

REV	LOCATIONS	DESCRIPTION	DATE	REVISOR	APPD
1		Part No. Change:FR-050MSS-DXX-HXX To FBB05002-MXXS1XX3XXM-HXX	29/OCT/13	JACOB	CHERRY
2		Structure Change	26/DEC/18	CHERRY	KATE
3		Add packaging specification	05/DEC/19	KATE	CHERRY

Electrical

Current Rating: 0.5A AC(rms)/DC
Voltage Rating: 50V AC(rms)/DC
Contact Resistance: 40 mΩ Max
Insulation Resistance: 100 MΩ MIN
Withstanding Voltage: 250V AC r.m.s
Temperature Range-Operating: -25°C~+85°C

Material and Plating

Housing: LCP(UL 94V-0)
Contact Pin: Phosphor Bronze
Plating: Gold Plated

Height H(in/mm)	Female H1(in/mm)	Male H2(in/mm)	F(in/mm)		
.118(3.00)	.087(2.20)	.031(0.80)	.063(1.60)		
.138(3.50)	.087(2.20)	.051(1.30)	.063(1.60)		
.157(4.00)	.118(3.00)	.039(1.00)	.075(1.90)		
.177(4.50)	.138(3.50)	.039(1.00)	.075(1.90)		
.197(5.00)	.157(4.00)	.118(3.00)	.039(1.00)	.079(2.00)	.075(1.90)
.217(5.50)	.177(4.50)	.039(1.00)	.075(1.90)		
.236(6.00)	.157(4.00)	.079(2.00)	.075(1.90)		
.256(6.50)	.177(4.50)	.079(2.00)	.075(1.90)		

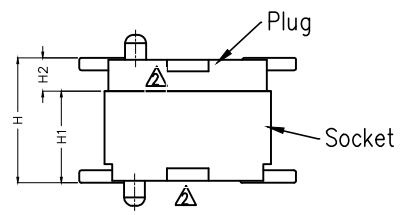
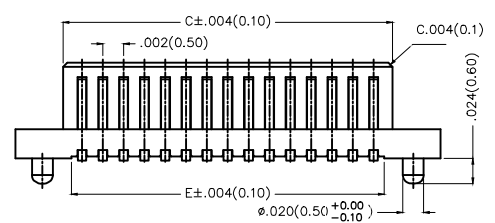
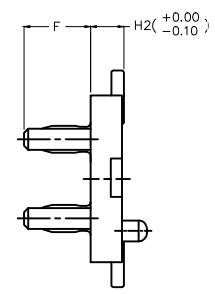
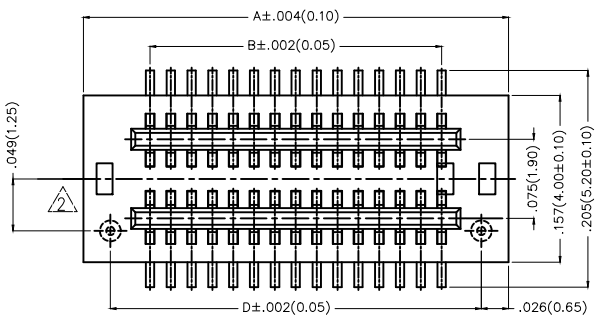

Mating Section

Ordering Information

FBB 050 02 - M XX S 1 XX 3 XX M HXX
1 2 3 4 5 6 7 8 9 10 11 12

1 Category FBB-Board To Board	2 Series Number 050-Pitch0.50mm	3 Distinction No. 02	4 Type M-Male	5 Circuits XX	6 Entry Angle S-180° Vertical
7 Plating 1-Gold Plated	8 Thickness of Plating 00-Gold Flash 03-3μ"	9 Material-Resin 3-LCP	10 Color-Resin K6-Black W5-White	11 Packaging M-Reel	12 Male Height H08-0.8mm H13-1.3mm

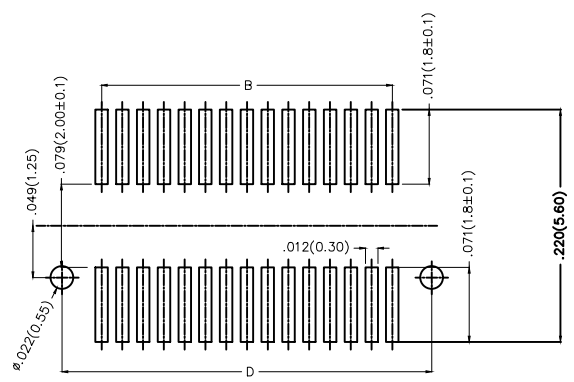



Recommended P.C.Board Layout

THIRD ANGLE PROJECTION		GENERAL TOLERANCES (UNLESS SPECIFIED)		APPROVE BY	DATE	PART NO.	TEM NO.	 Leader Of Industry
DESIGN UNITS	X.±.012(0.30)	X'.±5'	CHECKED BY	FRANK	26/SEPT/13	FBB05002-MXXS1XX3XXMHXX	FBB05002-M	
Inch (metric)	X.X±.008(0.20)	.X'±2'	CHERRY		26/SEPT/13	Board to Board Pitch 0.5mm 180° Vertical (SMT)		
SCALE	X.XX±.006(0.15)	.XX'±1'	DRAWN BY	JACOB	26/SEPT/13	THIS DRAWING CONTAINS INFORMATION THAT IS PROPRIETARY TO TXGA INDUSTRIAL ELECTRONICS(S.Z)CO.,LTD AND SHOULD NOT BE USED WITHOUT WRITTEN PERMISSION		REV 3
5:1	X.XXX±.004(0.10)	.XXX'±0.5'						SHEET NO. 1/3

REV	LOCATIONS	DESCRIPTION	DATE	REVISER	APPD

Circuits (n)	Part No. \triangle	Dimensions(in/mm)					Circuits (n)	Part No. \triangle	Dimensions(in/mm)				
		A	B	C	D	E			A	B	C	D	E
8	FBB05002-M08S1XX3XXMHXX	.185(4.70)	.059(1.50)	.098(2.50)	.134(3.40)	.079(2.00)	34	FBB05002-M34S1XX3XXMHXX	.441(11.20)	.315(8.00)	.354(9.00)	.390(9.90)	.335(8.50)
10	FBB05002-M10S1XX3XXMHXX	.205(5.20)	.079(2.00)	.118(3.00)	.154(3.90)	.098(2.50)	36	FBB05002-M36S1XX3XXMHXX	.461(11.70)	.335(8.50)	.374(9.50)	.409(10.40)	.354(9.00)
12	FBB05002-M12S1XX3XXMHXX	.224(5.70)	.098(2.50)	.138(3.50)	.173(4.40)	.118(3.00)	38	FBB05002-M38S1XX3XXMHXX	.480(12.20)	.354(9.00)	.394(10.00)	.429(10.90)	.374(9.50)
14	FBB05002-M14S1XX3XXMHXX	.244(6.20)	.118(3.00)	.157(4.00)	.193(4.90)	.138(3.50)	40	FBB05002-M40S1XX3XXMHXX	.500(12.70)	.374(9.50)	.413(10.50)	.449(11.40)	.394(10.00)
16	FBB05002-M16S1XX3XXMHXX	.264(6.70)	.138(3.50)	.177(4.50)	.213(5.40)	.157(4.00)	42	FBB05002-M42S1XX3XXMHXX	.520(13.20)	.394(10.00)	.429(10.90)	.469(11.90)	.413(10.50)
18	FBB05002-M18S1XX3XXMHXX	.283(7.20)	.157(4.00)	.197(5.00)	.232(5.90)	.177(4.50)	44	FBB05002-M44S1XX3XXMHXX	.539(13.70)	.413(10.50)	.453(11.50)	.488(12.40)	.433(11.00)
20	FBB05002-M20S1XX3XXMHXX	.303(7.70)	.177(4.50)	.217(5.50)	.252(6.40)	.197(5.00)	46	FBB05002-M46S1XX3XXMHXX	.559(14.20)	.433(11.00)	.472(12.00)	.508(12.90)	.453(11.50)
22	FBB05002-M22S1XX3XXMHXX	.323(8.20)	.197(5.00)	.236(6.00)	.272(6.90)	.217(5.50)	50	FBB05002-M50S1XX3XXMHXX	.598(15.20)	.472(12.00)	.512(13.00)	.547(13.90)	.492(12.50)
24	FBB05002-M24S1XX3XXMHXX	.343(8.70)	.217(5.50)	.256(6.50)	.291(7.40)	.236(6.00)	60	FBB05002-M60S1XX3XXMHXX	.697(17.70)	.571(14.50)	.610(15.50)	.646(16.40)	.591(15.00)
26	FBB05002-M26S1XX3XXMHXX	.362(9.20)	.236(6.00)	.276(7.00)	.311(7.90)	.256(6.50)	70	FBB05002-M70S1XX3XXMHXX	.795(20.20)	.669(17.00)	.709(18.00)	.744(18.90)	.689(17.50)
28	FBB05002-M28S1XX3XXMHXX	.382(9.70)	.256(6.50)	.295(7.50)	.331(8.40)	.276(7.00)	80	FBB05002-M80S1XX3XXMHXX	.894(22.70)	.768(19.50)	.807(20.50)	.843(21.40)	.787(20.00)
30	FBB05002-M30S1XX3XXMHXX	.402(10.20)	.276(7.00)	.315(8.00)	.350(8.90)	.295(7.50)	90	FBB05002-M90S1XX3XXMHXX	.992(25.20)	.866(22.00)	.906(23.00)	.941(23.90)	.886(22.50)
32	FBB05002-M32S1XX3XXMHXX	.421(10.70)	.295(7.50)	.335(8.50)	.370(9.40)	.315(8.00)	100	FBB05002-M100S1XX3XXMHXX	1.091(27.70)	.965(24.50)	1.004(25.50)	1.039(26.40)	.984(25.00)

 THIRD ANGLE PROJECTION	GENERAL TOLERANCES (UNLESS SPECIFIED)		APPROVE BY FRANK	DATE 26/SEPT/13	PART NO. FBB05002-MXXS1XX3XXMHXX	TEM NO. FBB05002-M	 Leader Of Industry
	DESIGN UNITS Inch (metric)	X. \pm .012(0.30) X.X \pm .008(0.20)	X. \pm 5' .X \pm 2'	CHECKED BY CHERRY	DATE 26/SEPT/13	TITLE Board to Board Pitch 0.5mm 180° Vertical (SMT)	
SCALE 5:1	SIZE A4	X.XX \pm .006(0.15) X.XXX \pm .004(0.10)	.XX \pm 1' .XXX \pm 0.5'	DRAWN BY JACOB	DATE 26/SEPT/13	THIS DRAWING CONTAINS INFORMATION THAT IS PROPRIETARY TO TXGA INDUSTRIAL ELECTRONICS(S.Z)CO.,LTD AND SHOULD NOT BE USED WITHOUT WRITTEN PERMISSION	

REV	LOCATIONS	DESCRIPTION	DATE	REVISER	APPD

A
B
C
D
E
F

A
B
C
D
E
F

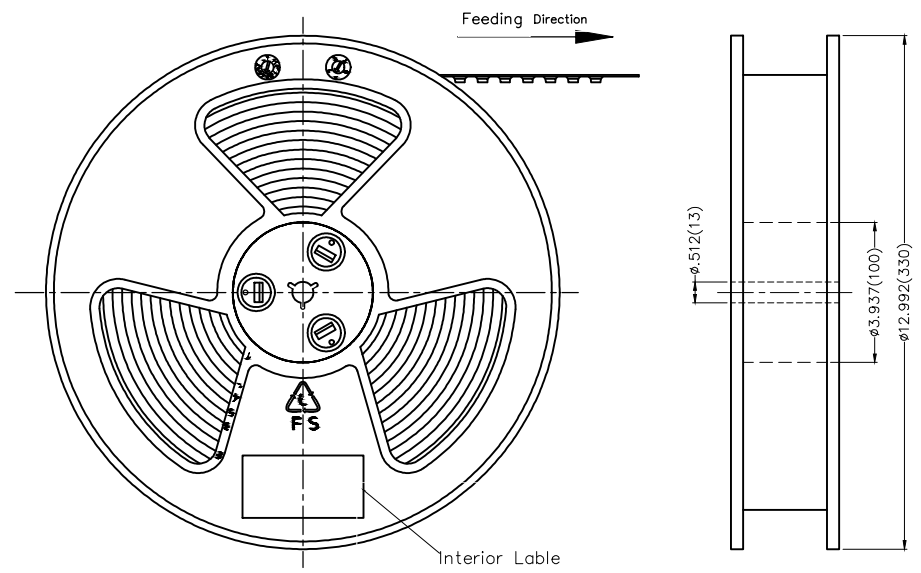

Note:

1. 10 sprocket hole cumulative tolerance ± 0.2
2. Carrier camber is within 1.0mm in 100mm
3. Material: Black Conductive polystyrene Alloy 100% recyclable
4. All dimensions meet EIA-481-B requirements
5. Peel off force of cover tape & carrier tape: 20g~130g(0.2N~1.3N)
6. Component load per 13" reel: 1,000 pcs

Circuits (n)	Dimensions(in/mm)		
	A	B	C
4~20	.630(16.0)	.295(7.50)	—
22~52	.945(24.0)	.453(11.50)	—
54~70	1.260(32.0)	.561(14.25)	1.122(28.50)
72~100	1.732(44.0)	.797(20.25)	1.594(40.50)

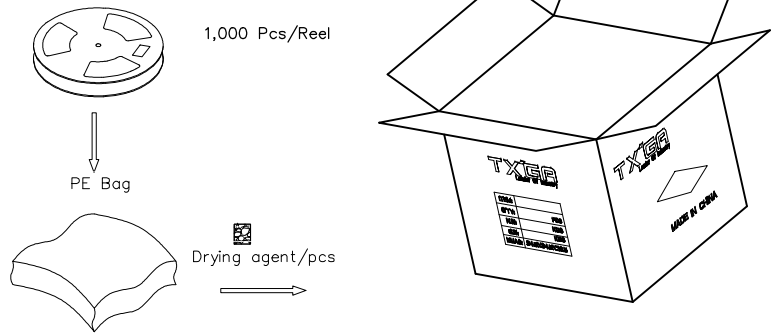
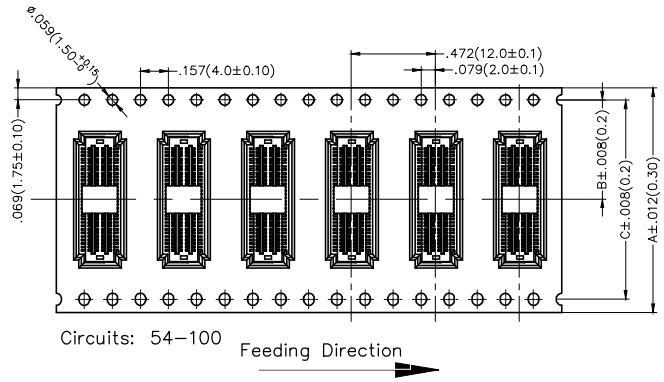
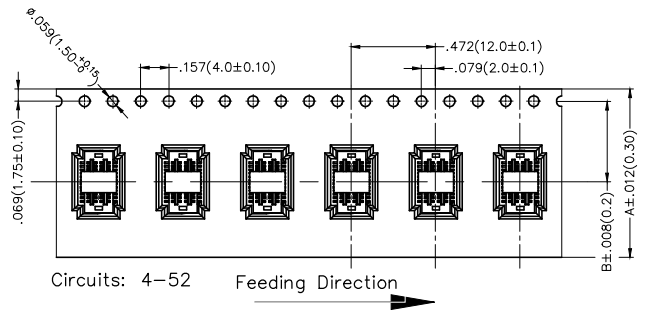
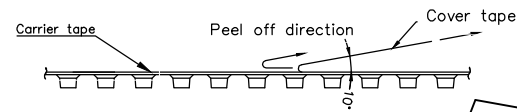
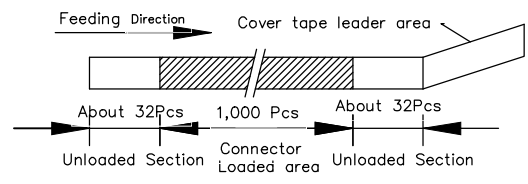

 THIRD ANGLE PROJECTION DESIGN UNITS Inch (metric) SCALE 5:1 SIZE A4	GENERAL TOLERANCES (UNLESS SPECIFIED)		APPROVE BY FRANK	DATE 05/DEC/19	PART NO. FBB05002-MXXS1XX3XXMHXX	ITEM NO. FBB05002-M	 Leader Of Industry
	X.±.012(0.30)	X.'±5'	CHECKED BY CHERRY	DATE 05/DEC/19	TITLE Board to Board Pitch 0.5mm 180° Vertical (SMT)		
	X.X±.008(0.20)	X.'±2'	DRAWN BY KATE	DATE 05/DEC/19	THIS DRAWING CONTAINS INFORMATION THAT IS PROPRIETARY TO TXGA INDUSTRIAL ELECTRONICS(S.Z)CO.,LTD AND SHOULD NOT BE USED WITHOUT WRITTEN PERMISSION		SHEET NO. 3/3
	X.XX±.006(0.15)	.XX'±1'					
	X.XXX±.004(0.10)	.XXX'±0.5'					