

REV	LOCATIONS	DESCRIPTION	DATE	REVISER	APPD

**Electrical**

Current Rating: 3A AC(rms)/DC  
Voltage Rating: 250V AC(rms)/DC  
Contact Resistance: 25 mΩ Max  
Insulation Resistance: 1000 MΩ MIN  
Withstanding Voltage: 500V AC r.m.s  
Temperature Range—Operating: -55°C~+105°C

**Material and Plating**

Housing: PBT( UL 94V-0)  
Contact Pin: Phosphor Bronze  
Plating: Selective gold in contact area, tin on tail

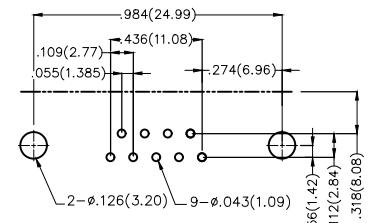
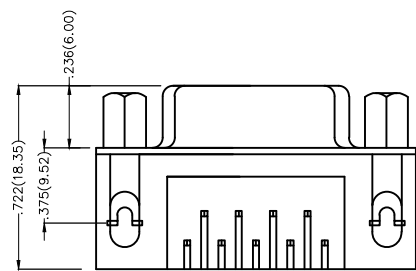
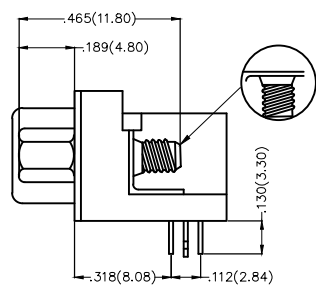
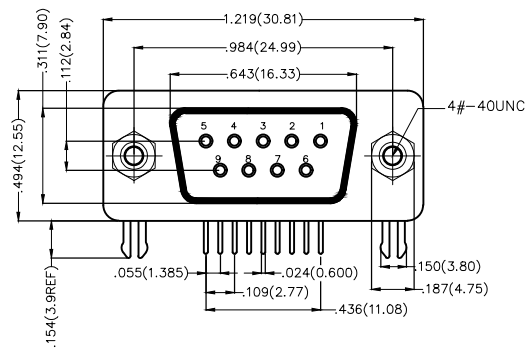

Recommended P.C.Board Layout

**Ordering Information**

FDB 09 02 - F0 D B 3 XX XX X A  
1 2 3 4 5 6 7 8 9 10 11

1	Category FDB-D-SUB Connectors	2	Circuits 09-9Circuits	3	Distinction No. 02	4	Type F0-Female	5	Assembly Layout D-DIP	6	Entry Angle B-90° Angle
7	Plating 3-Selective gold in contact area, tin on tail	8	Thickness of Plating 00-Gold Flash 03-3μ" Custom plate available	9	Color-Resin K6-Black U1-Blue	10	Packaging L-Tube K-Tray	11	Distinction Type A-A Type		

 THIRD ANGLE PROJECTION	GENERAL TOLERANCES (UNLESS SPECIFIED)		APPROVE BY FRANK	DATE 28/JUN/13	PART NO. FDB0902-F0DB3XXXXXX	ITEM NO. FDB0902	 Leader Of Industry	
	DESIGN UNITS Inch (metric)	X.X±.012(0.30) X.X±.008(0.20) X.XX±.006(0.15) X.XXX±.004(0.10)	X'.±5' .X'±2' .XX'±1' .XXX'±0.5'	CHECKED BY JACOB	DATE 28/JUN/13	TITLE D-SUB Connectors 9 Circuits 90° Angle Female		REV 0
SCALE 5:1	SIZE A4	DRAWN BY CHERRY		DATE 28/JUN/13	THIS DRAWING CONTAINS INFORMATION THAT IS PROPRIETARY TO TXGA INDUSTRIAL ELECTRONICS(S.Z)CO.,LTD AND SHOULD NOT BE USED WITHOUT WRITTEN PERMISSION			

REV	LOCATIONS	DESCRIPTION	DATE	REVISER	APPD

**Electrical**

Current Rating: 3A AC(rms)/DC  
Voltage Rating: 250V AC(rms)/DC  
Contact Resistance: 25 mΩ Max  
Insulation Resistance: 1000 MΩ MIN  
Withstanding Voltage: 500V AC r.m.s  
Temperature Range—Operating: -55°C~+105°C

**Material and Plating**

Housing: PBT( UL 94V-0)  
Contact Pin: Phosphor Bronze  
Plating: Selective gold in contact area, tin on tail

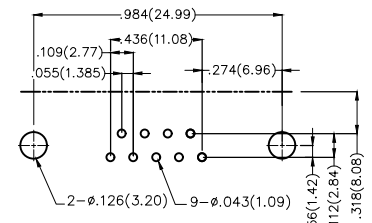
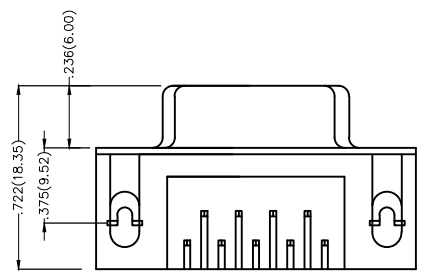
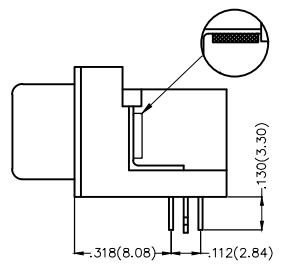
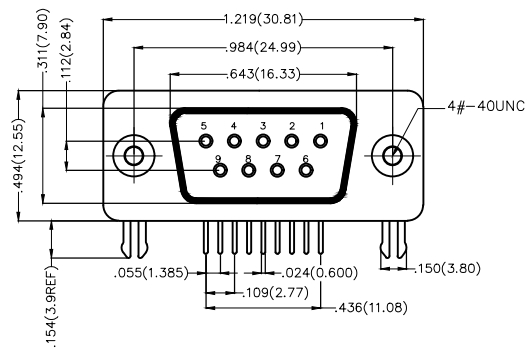

Recommended P.C.Board Layout

**Ordering Information**

FDB 09 02 - F0 D B 3 XX XX X B  
1 2 3 4 5 6 7 8 9 10 11

1	Category FDB-D-SUB Connectors	2	Circuits 09-9Circuits	3	Distinction No. 02	4	Type F0-Female	5	Assembly Layout D-DIP	6	Entry Angle B-90° Angle
7	Plating 3-Selective gold in contact area, tin on tail	8	Thickness of Plating 00-Gold Flash 03-3μ" Custom plate available	9	Color-Resin K6-Black U1-Blue	10	Packaging L-Tube K-Tray	11	Distinction Type B-B Type		

 THIRD ANGLE PROJECTION	GENERAL TOLERANCES (UNLESS SPECIFIED)		APPROVE BY FRANK	DATE 28/JUN/13	PART NO. FDB0902-F0DB3XXXXXB	ITEM NO. FDB0902	 Leader Of Industry	
	DESIGN UNITS Inch (metric)	X.±.012(0.30) X.X±.008(0.20) X.XX±.006(0.15) X.XXX±.004(0.10)	X'.±5' .X'±2' .XX'±1' .XXX'±0.5'	CHECKED BY JACOB	DATE 28/JUN/13	TITLE D-SUB Connectors 9 Circuits 90° Angle Female		REV 0
SCALE 5:1	SIZE A4	DRAWN BY CHERRY		DATE 28/JUN/13	THIS DRAWING CONTAINS INFORMATION THAT IS PROPRIETARY TO TXGA INDUSTRIAL ELECTRONICS(S.Z)CO.,LTD AND SHOULD NOT BE USED WITHOUT WRITTEN PERMISSION			

REV	LOCATIONS	DESCRIPTION	DATE	REVISER	APPD

**Electrical**

Current Rating: 3A AC(rms)/DC  
Voltage Rating: 250V AC(rms)/DC  
Contact Resistance: 25 mΩ Max  
Insulation Resistance: 1000 MΩ MIN  
Withstanding Voltage: 500V AC r.m.s  
Temperature Range—Operating: -55°C~+105°C

**Material and Plating**

Housing: PBT( UL 94V-0)  
Contact Pin: Phosphor Bronze  
Plating: Selective gold in contact area, tin on tail

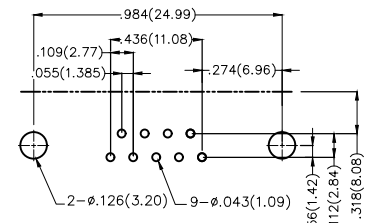
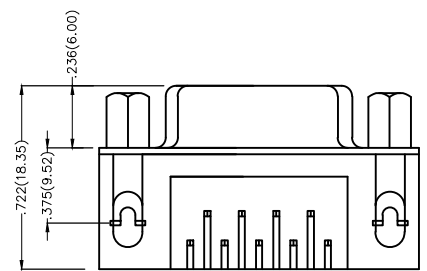
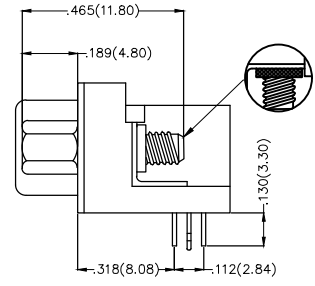
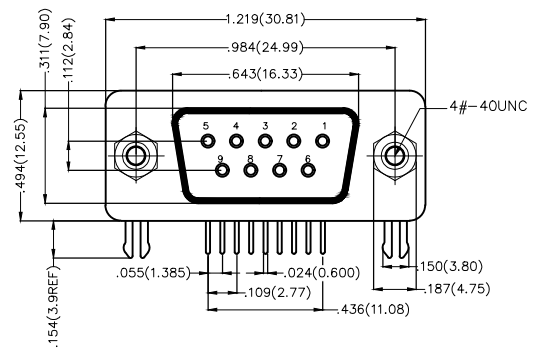

Recommended P.C.Board Layout

**Ordering Information**

FDB 09 02 - F0 D B 3 XX XX X C  
1 2 3 4 5 6 7 8 9 10 11

1	Category FDB-D-SUB Connectors	2	Circuits 09-9Circuits	3	Distinction No. 02	4	Type F0-Female	5	Assembly Layout D-DIP	6	Entry Angle B-90° Angle
7	Plating 3-Selective gold in contact area, tin on tail	8	Thickness of Plating 00-Gold Flash 03-3μ" Custom plate available	9	Color-Resin K6-Black U1-Blue	10	Packaging L-Tube K-Tray	11	Distinction Type C-C Type		

THIRD ANGLE PROJECTION	GENERAL TOLERANCES (UNLESS SPECIFIED)		APPROVE BY FRANK	DATE 28/JUN/13	PART NO. FDB0902-F0DB3XXXXXC	ITEM NO. FDB0902	 Leader Of Industry	
	DESIGN UNITS Inch (metric)	X.±.012(0.30) X.X±.008(0.20) X.XX±.006(0.15) X.XXX±.004(0.10)	X'.±5' .X'±2' .XX'±1' .XXX'±0.5'	CHECKED BY JACOB	DATE 28/JUN/13	TITLE D-SUB Connectors 9 Circuits 90° Angle Female		REV 0
SCALE 5:1	SIZE A4	DRAWN BY CHERRY		DATE 28/JUN/13	THIS DRAWING CONTAINS INFORMATION THAT IS PROPRIETARY TO TXGA INDUSTRIAL ELECTRONICS(S.Z)CO.,LTD AND SHOULD NOT BE USED WITHOUT WRITTEN PERMISSION			

REV	LOCATIONS	DESCRIPTION	DATE	REVISER	APPD

**Electrical**

Current Rating: 3A AC(rms)/DC  
Voltage Rating: 250V AC(rms)/DC  
Contact Resistance: 25 mΩ Max  
Insulation Resistance: 1000 MΩ MIN  
Withstanding Voltage: 500V AC r.m.s  
Temperature Range—Operating: -55°C~+105°C

**Material and Plating**

Housing: PBT( UL 94V-0)  
Contact Pin: Phosphor Bronze  
Plating: Selective gold in contact area, tin on tail

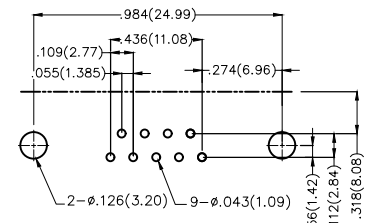
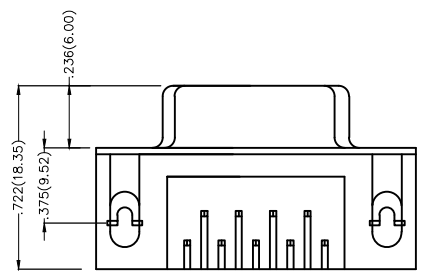
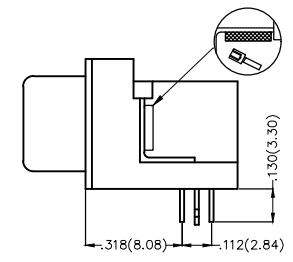
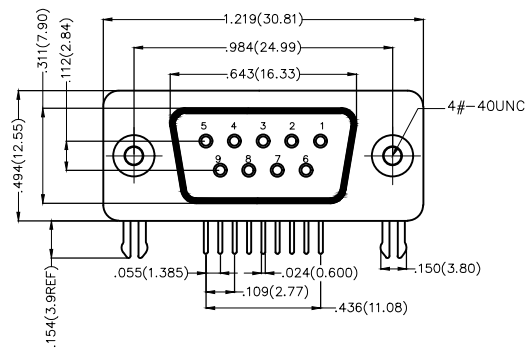

Recommended P.C.Board Layout

**Ordering Information**

FDB 09 02 - F0 D B 3 XX XX X D  
1 2 3 4 5 6 7 8 9 10 11

1	Category FDB-D-SUB Connectors	2	Circuits 09-9Circuits	3	Distinction No. 02	4	Type F0-Female	5	Assembly Layout D-DIP	6	Entry Angle B-90° Angle
7	Plating 3-Selective gold in contact area, tin on tail	8	Thickness of Plating 00-Gold Flash 03-3μ" Custom plate available	9	Color-Resin K6-Black U1-Blue	10	Packaging L-Tube K-Tray	11	Distinction Type D-D Type		

 THIRD ANGLE PROJECTION	GENERAL TOLERANCES (UNLESS SPECIFIED)		APPROVE BY FRANK	DATE 28/JUN/13	PART NO. FDB0902-F0DB3XXXXX	ITEM NO. FDB0902	 Leader Of Industry	
	DESIGN UNITS Inch (metric)	X.±.012(0.30) X.X±.008(0.20) X.XX±.006(0.15) X.XXX±.004(0.10)	X'.±5' .X'±2' .XX'±1' .XXX'±0.5'	CHECKED BY JACOB	DATE 28/JUN/13	TITLE D-SUB Connectors 9 Circuits 90° Angle Female		REV 0
SCALE 5:1	SIZE A4	DRAWN BY CHERRY		DATE 28/JUN/13	THIS DRAWING CONTAINS INFORMATION THAT IS PROPRIETARY TO TXGA INDUSTRIAL ELECTRONICS(S.Z)CO.,LTD AND SHOULD NOT BE USED WITHOUT WRITTEN PERMISSION			

REV	LOCATIONS	DESCRIPTION	DATE	REVISER	APPD
1	△	Size changes	01/APR/20	KATE	CHERRY

Electrical

Current Rating: 3A AC(rms)/DC  
Voltage Rating: 250V AC(rms)/DC  
Contact Resistance: 25 mΩ Max  
Insulation Resistance: 1000 MΩ MIN  
Withstanding Voltage: 500V AC r.m.s  
Temperature Range—Operating: -55°C~+105°C

Material and Plating

Housing: PBT( UL 94V-0)  
Contact Pin: Phosphor Bronze  
Plating: Selective gold in contact area, tin on tail

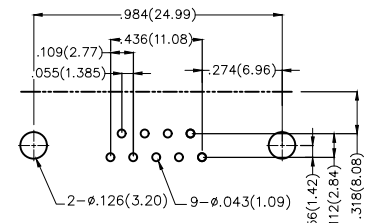
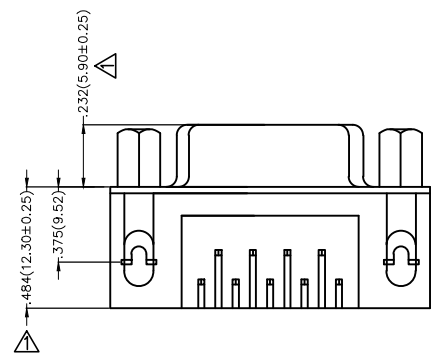
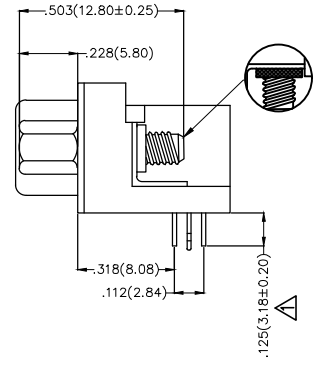
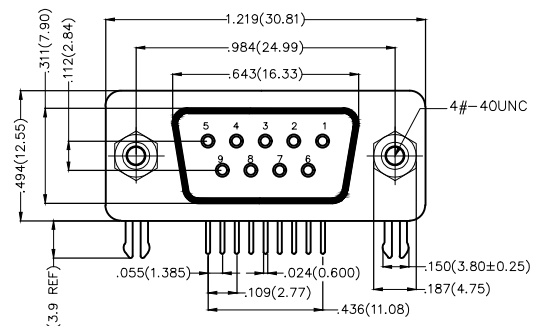

Recommended P.C.Board Layout

Ordering Information

FDB 09 02 - F0 D B 3 XX XX X E  
1 2 3 4 5 6 7 8 9 10 11

1	Category FDB-D-SUB Connectors	2	Circuits 09-9Circuits	3	Distinction No. 02	4	Type F0-Female	5	Assembly Layout D-DIP	6	Entry Angle B-90° Angle
7	Plating 3-Selective gold in contact area, tin on tail	8	Thickness of Plating 00-Gold Flash 03-3μ Custom plate available	9	Color-Resin K6-Black U1-Blue	10	Packaging L-Tube K-Tray	11	Distinction Type E-E Type		

THIRD ANGLE PROJECTION	GENERAL TOLERANCES (UNLESS SPECIFIED)		APPROVE BY FRANK	DATE 28/JUN/13	PART NO. FDB0902-F0DB3XXXXXE	ITEM NO. FDB0902	 Leader Of Industry	
	DESIGN UNITS Inch (metric)	X.±.012(0.30) X.X±.008(0.20) X.XX±.006(0.15) X.XXX±.004(0.10)	X'±5' X'±2' .XX±1" .XXX±0.5'	CHECKED BY JACOB	DATE 28/JUN/13	TITLE D-SUB Connectors 9 Circuits 90° Angle Female		REV 1
SCALE 5:1	SIZE A4		DRAWN BY CHERRY	DATE 28/JUN/13	THIS DRAWING CONTAINS INFORMATION THAT IS PROPRIETARY TO TXGA INDUSTRIAL ELECTRONICS(S.Z)CO.,LTD AND SHOULD NOT BE USED WITHOUT WRITTEN PERMISSION			