

1 2 3 4 5 6 7 8

REV	LOCATIONS	DESCRIPTION	DATE	REVISER	APPD

SPECIFICATIONS

Electrical
 Current Rating: 1A AC(rms)/DC
 Voltage Rating: 250V AC(rms)/DC
 Contact Resistance: 30 mΩ Max
 Insulation Resistance: 1000 MΩ Min
 Withstanding Voltage: 500V AC r.m.s
 Temperature Range-Operating: -20°C~+85°C

Material and Plating
 Housing: Thermoplastic (UL 94V-0) Black
 Pin: Copper Alloy/ Gold Plated
 Shell: Copper Alloy/ Nickel Plated

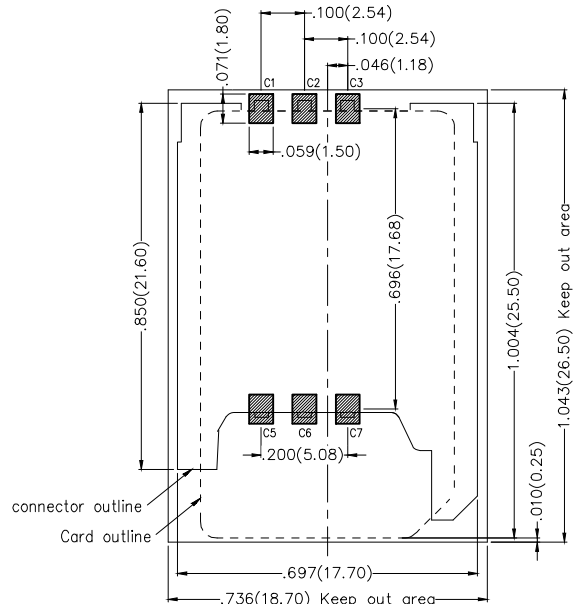
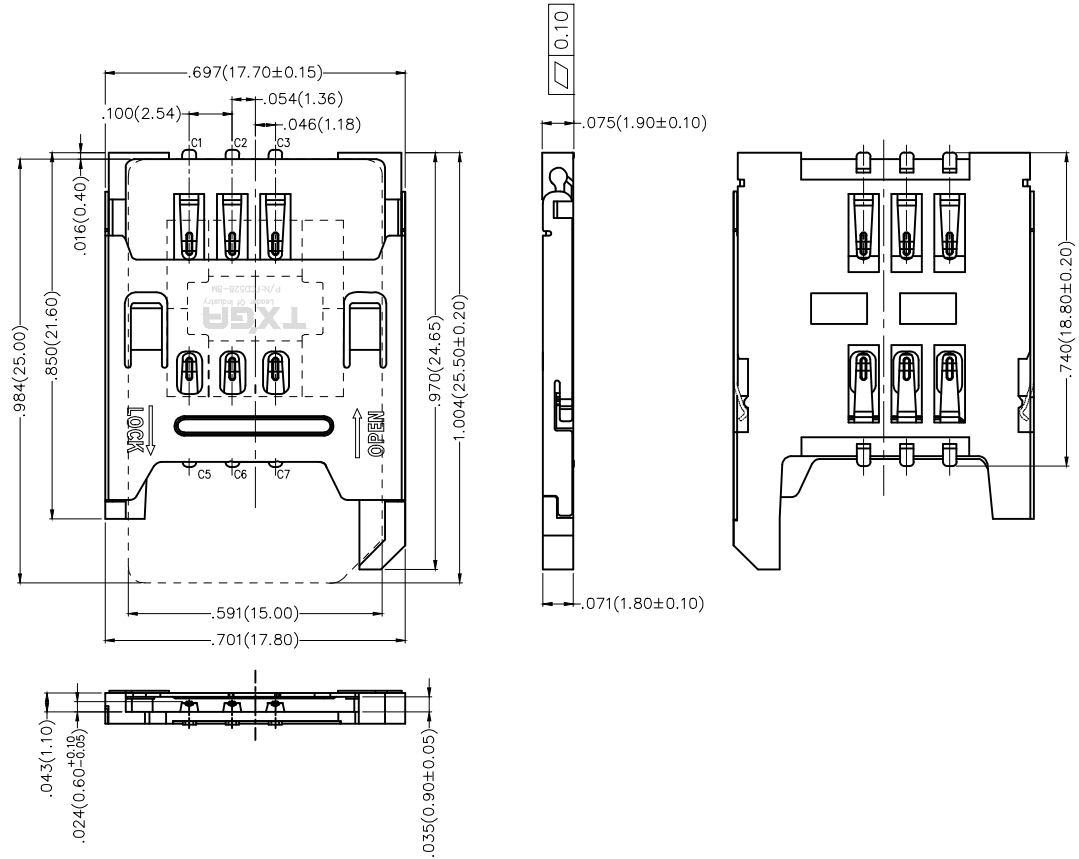

Recommended P.C.Board Layout
 General Tolerances: ±0.05mm

Circuits	Description
C1	Supply voltage vcc
C2	Reset (RST)
C3	Clock (CLK)
C4	N/A
C5	Ground
C6	Programming voltage vpp
C7	I/O
C8	N/A

<p>THIRD ANGLE PROJECTION</p>	GENERAL TOLERANCES (UNLESS SPECIFIED)		APPROVE BY	DATE	PART NO.	ITEM NO.
	X.±.012(0.30)	X.±5'	FRANK	02/DEC/16		
	X.X±.008(0.20)	X.±2'	CHECKED BY	DATE	TITLE	
	X.XX±.006(0.15)	.XX±1'	CHERRY	02/DEC/16	SIM card connector(H:1.8mm)	
SCALE	SIZE	X.XXX±.004(0.10)	.XXX±0.5'	DRAWN BY	DATE	THIS DRAWING CONTAINS INFORMATION THAT IS PROPRIETARY TO TXGA INDUSTRIAL ELECTRONICS(S.Z)CO.,LTD AND SHOULD NOT BE USED WITHOUT WRITTEN PERMISSION
5:1	A4	KATE	02/DEC/16	REV 0 SHEET NO. 1/2		



1 2 3 4 5 6 7 8

1 2 3 4 5 6 7 8

REV	LOCATIONS	DESCRIPTION	DATE	REVISER	APPD

- Note:**
- 10 sprocket hole cumulative tolerance $\pm 0.008(0.2)$
 - Carrier camber is within 1.0mm in 100mm
 - Material: Black Conductive polystyrene Alloy 100% recyclable
 - All dimensions meet EIA-481-3 requirements
 - Component load per 13" reel: 1,000pcs

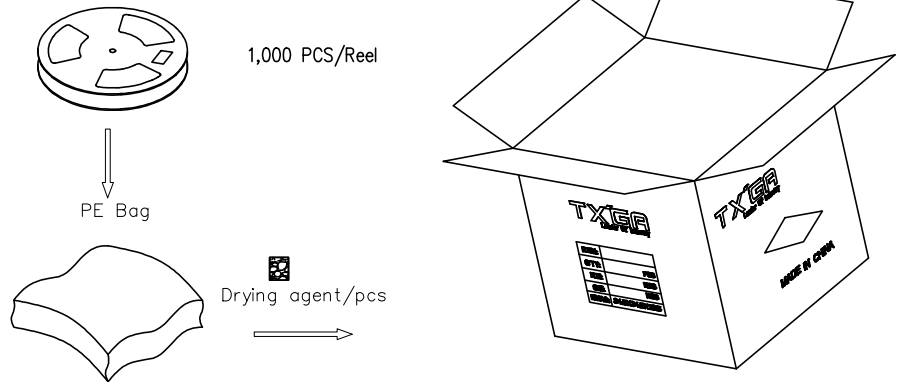
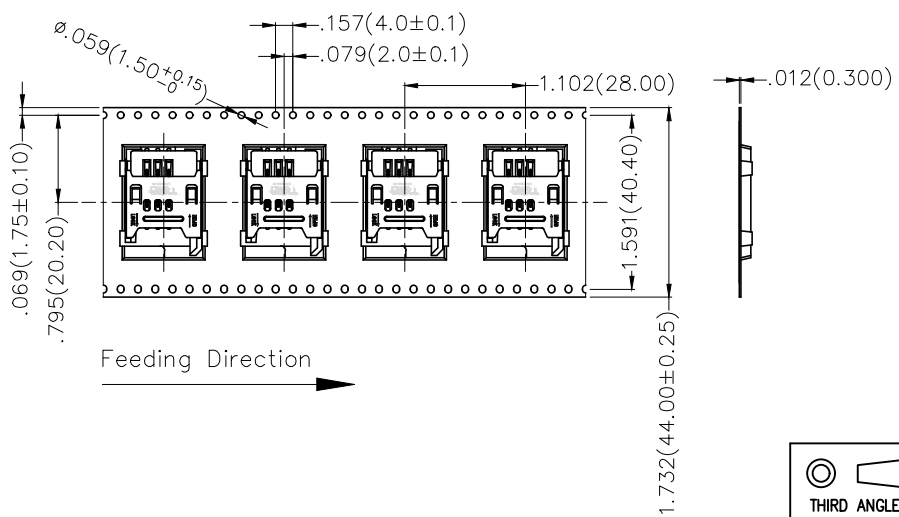
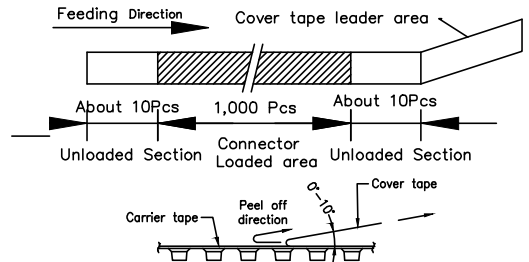
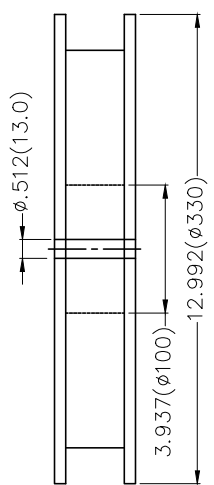
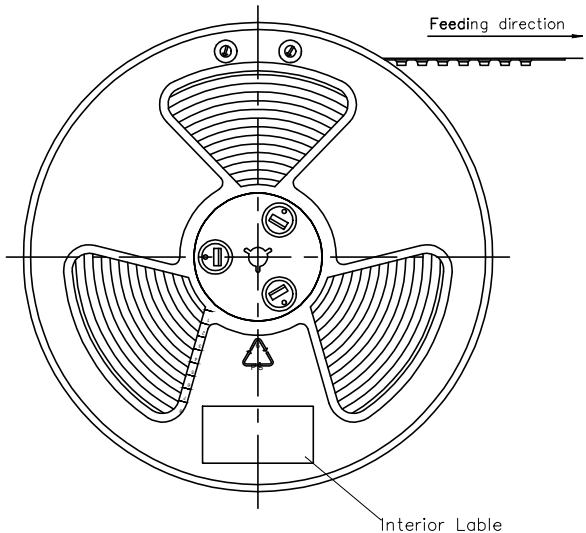

<p>THIRD ANGLE PROJECTION</p>	GENERAL TOLERANCES (UNLESS SPECIFIED)		APPROVE BY FRANK	DATE 02/DEC/16	PART NO. FCD528-8M	ITEM NO. FCD528	<p>Leader Of Industry</p>
	X. $\pm 0.12(0.30)$	X. $\pm 5^\circ$	CHECKED BY CHERRY	DATE 02/DEC/16	TITLE SIM card connector(H:1.8mm)		
DESIGN UNITS Inch (metric)	X.X $\pm 0.008(0.20)$.X $\pm 2^\circ$	DRAWN BY KATE	DATE 02/DEC/16	THIS DRAWING CONTAINS INFORMATION THAT IS PROPRIETARY TO TXGA INDUSTRIAL ELECTRONICS(S.Z)CO.,LTD AND SHOULD NOT BE USED WITHOUT WRITTEN PERMISSION		
SCALE 5:1	SIZE A4	X.XX $\pm 0.006(0.15)$					
		X.XXX $\pm 0.004(0.10)$					

1 2 3 4 5 6 7 8