

1 2 3 4 5 6 7 8

REV	LOCATIONS	DESCRIPTION	DATE	REVISER	APPD

Electrical

Current Rating: 3A AC(rms)/DC  
 Voltage Rating: 250V AC(rms)/DC  
 Contact Resistance: 20 mΩ Max  
 Insulation Resistance: 1000 MΩ MIN  
 Withstanding Voltage: 500V AC r.m.s  
 Temperature Range-Operating: -40°C~+105°C

Material and Plating

Housing: PBT/PA6T( UL 94V-0)  
 Contact Pin: Brass  
 Plating: Gold Plated/Selective gold on contact area, tin on tail

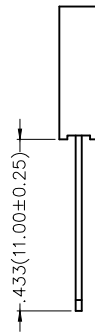
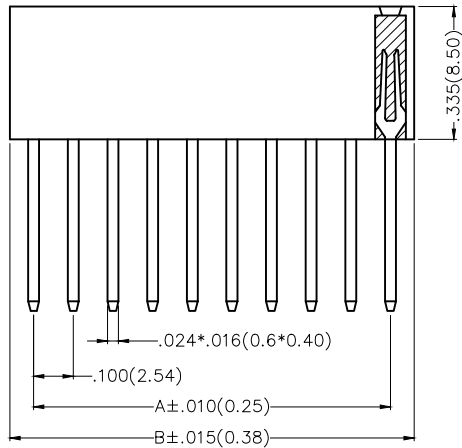
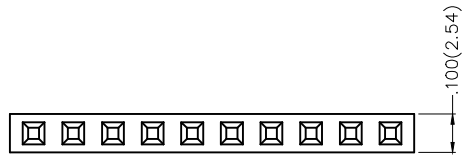

Ordering Information

FFH 254 47 — S XX S X XX X K6 X  
 1 2 3 4 5 6 7 8 9 10 11

1 Category FFH-Female Header	2 Series Number 254-Pitch2.54mm	3 Distinction No. 47	4 Row Option S-Single row	5 Circuits XX	6 Entry Angle S-180° Vertical
7 Plating 1-Gold Plated 3-Selective gold on contact area, tin on tail	8 Thickness of Plating 00-Gold Flash 05-5μ" Custom plate available	9 Material-Resin 1-PBT 4-PA6T	10 Color-Resin K6-Black	11 Packaging K-Tray L-PE Tube	

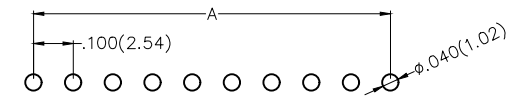



Recommended P.C.Board Layout

THIRD ANGLE PROJECTION	GENERAL TOLERANCES (UNLESS SPECIFIED)		APPROVE BY FRANK	DATE 12/AUG/13	PART NO. FFH25447-SXXSXXXK6X	ITEM NO. FFH25447	 Leader Of Industry
	DESIGN UNITS Inch (metric)	X.±.012(0.30) X'±5" X.X±.008(0.20) .X'±2"	CHECKED BY CHERRY	DATE 12/AUG/13	TITLE Board to Board (Female Header) Pitch 2.54mm 180° Vertical (DIP)		
SCALE 5:1	SIZE A4	X.XX±.006(0.15) .XX'±1" X.XXX±.004(0.10) .XXX'±0.5"	DRAWN BY JACOB	DATE 12/AUG/13	THIS DRAWING CONTAINS INFORMATION THAT IS PROPRIETARY TO TXGA INDUSTRIAL ELECTRONICS(S.Z)CO.,LTD AND SHOULD NOT BE USED WITHOUT WRITTEN PERMISSION		

1 2 3 4 5 6 7 8

REV	LOCATIONS	DESCRIPTION	DATE	REVSER	APPD

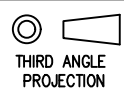
Circuits (n)	Part No.	Dimensions(in/mm)		Circuits (n)	Part No.	Dimensions(in/mm)	
		A	B			A	B
2	FFH25447-S02SXXXXK6X	.100(2.54)	.220(5.58)	22	FFH25447-S22SXXXXK6X	2.100(53.34)	2.220(56.38)
3	FFH25447-S03SXXXXK6X	.200(5.08)	.320(8.12)	23	FFH25447-S23SXXXXK6X	2.200(55.88)	2.320(58.92)
4	FFH25447-S04SXXXXK6X	.300(7.62)	.420(10.66)	24	FFH25447-S24SXXXXK6X	2.300(58.42)	2.420(61.46)
5	FFH25447-S05SXXXXK6X	.400(10.16)	.520(13.20)	25	FFH25447-S25SXXXXK6X	2.400(60.96)	2.520(64.00)
6	FFH25447-S06SXXXXK6X	.500(12.70)	.620(15.74)	26	FFH25447-S26SXXXXK6X	2.500(63.50)	2.620(66.54)
7	FFH25447-S07SXXXXK6X	.600(15.24)	.720(18.28)	27	FFH25447-S27SXXXXK6X	2.600(66.04)	2.720(69.08)
8	FFH25447-S08SXXXXK6X	.700(17.78)	.820(20.82)	28	FFH25447-S28SXXXXK6X	2.700(68.58)	2.820(71.62)
9	FFH25447-S09SXXXXK6X	.800(20.32)	.920(23.36)	29	FFH25447-S29SXXXXK6X	2.800(71.12)	2.920(74.16)
10	FFH25447-S10SXXXXK6X	.900(22.86)	1.020(25.90)	30	FFH25447-S30SXXXXK6X	2.900(73.66)	3.020(76.70)
11	FFH25447-S11SXXXXK6X	1.000(25.40)	1.120(28.44)	31	FFH25447-S31SXXXXK6X	3.000(76.20)	3.120(79.24)
12	FFH25447-S12SXXXXK6X	1.100(27.94)	1.220(30.98)	32	FFH25447-S32SXXXXK6X	3.100(78.74)	3.220(81.78)
13	FFH25447-S13SXXXXK6X	1.200(30.48)	1.320(33.52)	33	FFH25447-S33SXXXXK6X	3.200(81.28)	3.320(84.32)
14	FFH25447-S14SXXXXK6X	1.300(33.02)	1.420(36.06)	34	FFH25447-S34SXXXXK6X	3.300(83.82)	3.420(86.86)
15	FFH25447-S15SXXXXK6X	1.400(35.56)	1.520(38.60)	35	FFH25447-S35SXXXXK6X	3.400(86.36)	3.520(89.40)
16	FFH25447-S16SXXXXK6X	1.500(38.10)	1.620(41.14)	36	FFH25447-S36SXXXXK6X	3.500(88.90)	3.620(91.94)
17	FFH25447-S17SXXXXK6X	1.600(40.64)	1.720(43.68)	37	FFH25447-S37SXXXXK6X	3.600(91.44)	3.720(94.48)
18	FFH25447-S18SXXXXK6X	1.700(43.18)	1.820(46.22)	38	FFH25447-S38SXXXXK6X	3.700(93.98)	3.820(97.02)
19	FFH25447-S19SXXXXK6X	1.800(45.72)	1.920(48.76)	39	FFH25447-S39SXXXXK6X	3.800(96.52)	3.920(99.56)
20	FFH25447-S20SXXXXK6X	1.900(48.26)	2.020(51.30)	40	FFH25447-S40SXXXXK6X	3.900(99.06)	4.020(102.10)
21	FFH25447-S21SXXXXK6X	2.000(50.80)	2.120(53.84)				

 THIRD ANGLE PROJECTION	GENERAL TOLERANCES (UNLESS SPECIFIED)		APPROVE BY FRANK	DATE 12/AUG/13	PART NO. FFH25447-SXXSXXXXK6X	ITEM NO. FFH25447	 Leader Of Industry	
	X.±.012(0.30)	X.±5'	CHECKED BY CHERRY	DATE 12/AUG/13	TITLE Board to Board (Female Header) Pitch 2.54mm 180° Vertical (DIP)			REV 0
	DESIGN UNITS Inch (metric)	X.X±.008(0.20)	.X±2'	DRAWN BY JACOB	DATE 12/AUG/13	THIS DRAWING CONTAINS INFORMATION THAT IS PROPRIETARY TO TXGA INDUSTRIAL ELECTRONICS(S.Z)CO.,LTD AND SHOULD NOT BE USED WITHOUT WRITTEN PERMISSION		
	SCALE 5:1	SIZE A4	X.XX±.006(0.15)	.XX±1'	X.XXX±.004(0.10)	.XX±0.5'		

REV	LOCATIONS	DESCRIPTION	DATE	REVISER	APPD

Electrical

Current Rating: 3A AC(rms)/DC  
 Voltage Rating: 250V AC(rms)/DC  
 Contact Resistance: 20 mΩ Max  
 Insulation Resistance: 1000 MΩ MIN  
 Withstanding Voltage: 500V AC r.m.s  
 Temperature Range: -40°C ~ +105°C

Material and Plating

Housing: PBT/PA6T( UL 94V-0)  
 Contact Pin: Brass  
 Plating: Gold Plated/Selective gold on contact area,  
 tin on tail

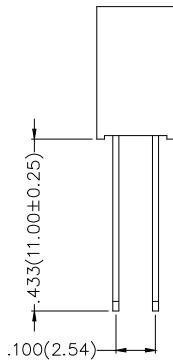
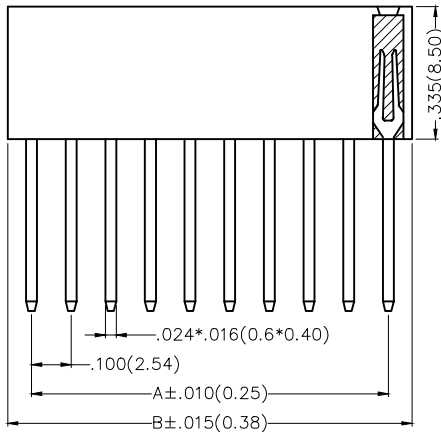
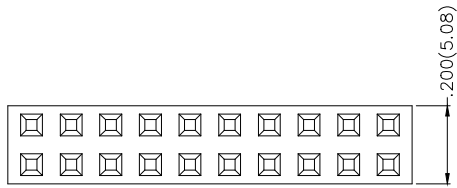

Ordering Information

FFH 254 47 — D XX S X XX X K6 X  
 1 2 3 4 5 6 7 8 9 10 11

1 Category FFH—Female Header	2 Series Number 254—Pitch 2.54mm	3 Distinction No. 47	4 Row Option D—Double Row	5 Circuits XX	6 Entry Angle S—180° Vertical
7 Plating 1—Gold Plated 3—Selective gold on contact area, tin on tail	8 Thickness of Plating 00—Gold Flash 05—5μ" Custom plate available	9 Material—Resin 1—PBT 4—PA6T	10 Color—Resin K6—Black	11 Packaging K—Tray L—PE Tube	

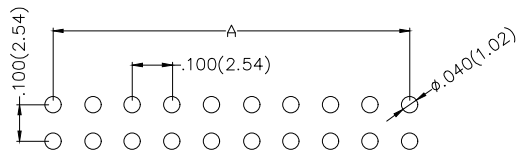

Recommended P.C.Board Layout

THIRD ANGLE PROJECTION	GENERAL TOLERANCES (UNLESS SPECIFIED)		APPROVE BY FRANK	DATE 12/AUG/13	PART NO. FFH25447-DXXSXXXK6X	ITEM NO. FFH25447	 Leader Of Industry
	DESIGN UNITS Inch (metric)	X.±.012(0.30) X'±5'	CHECKED BY CHERRY	DATE 12/AUG/13	TITLE Board to Board (Female Header) Pitch 2.54mm 180° Vertical (DIP)		
SCALE 5:1	SIZE A4	X.XX±.006(0.15) .XX'±1"	DRAWN BY JACOB	DATE 12/AUG/13	THIS DRAWING CONTAINS INFORMATION THAT IS PROPRIETARY TO TXGA INDUSTRIAL ELECTRONICS(S.Z)CO.,LTD AND SHOULD NOT BE USED WITHOUT WRITTEN PERMISSION		

1 2 3 4 5 6 7 8

REV	LOCATIONS	DESCRIPTION	DATE	REVSER	APPD

A

A

B

B

C

C

D

D



E

E

F

F

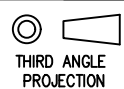
Circuits (n)	Part No.	Dimensions(in/mm)		Circuits (n)	Part No.	Dimensions(in/mm)	
		A	B			A	B
4	FFH25447-D04SXXXXK6X	.100(2.54)	.220(5.58)	44	FFH25447-D44SXXXXK6X	2.100(53.34)	2.220(56.38)
6	FFH25447-D06SXXXXK6X	.200(5.08)	.320(8.12)	46	FFH25447-D46SXXXXK6X	2.200(55.88)	2.320(58.92)
8	FFH25447-D08SXXXXK6X	.300(7.62)	.420(10.66)	48	FFH25447-D48SXXXXK6X	2.300(58.42)	2.420(61.46)
10	FFH25447-D10SXXXXK6X	.400(10.16)	.520(13.20)	50	FFH25447-D50SXXXXK6X	2.400(60.96)	2.520(64.00)
12	FFH25447-D12SXXXXK6X	.500(12.70)	.620(15.74)	52	FFH25447-D52SXXXXK6X	2.500(63.50)	2.620(66.54)
14	FFH25447-D14SXXXXK6X	.600(15.24)	.720(18.28)	54	FFH25447-D54SXXXXK6X	2.600(66.04)	2.720(69.08)
16	FFH25447-D16SXXXXK6X	.700(17.78)	.820(20.82)	56	FFH25447-D56SXXXXK6X	2.700(68.58)	2.820(71.62)
18	FFH25447-D18SXXXXK6X	.800(20.32)	.920(23.36)	58	FFH25447-D58SXXXXK6X	2.800(71.12)	2.920(74.16)
20	FFH25447-D20SXXXXK6X	.900(22.86)	1.020(25.90)	60	FFH25447-D60SXXXXK6X	2.900(73.66)	3.020(76.70)
22	FFH25447-D22SXXXXK6X	1.000(25.40)	1.120(28.44)	62	FFH25447-D62SXXXXK6X	3.000(76.20)	3.120(79.24)
24	FFH25447-D24SXXXXK6X	1.100(27.94)	1.220(30.98)	64	FFH25447-D64SXXXXK6X	3.100(78.74)	3.220(81.78)
26	FFH25447-D26SXXXXK6X	1.200(30.48)	1.320(33.52)	66	FFH25447-D66SXXXXK6X	3.200(81.28)	3.320(84.32)
28	FFH25447-D28SXXXXK6X	1.300(33.02)	1.420(36.06)	68	FFH25447-D68SXXXXK6X	3.300(83.82)	3.420(86.86)
30	FFH25447-D30SXXXXK6X	1.400(35.56)	1.520(38.60)	70	FFH25447-D70SXXXXK6X	3.400(86.36)	3.520(89.40)
32	FFH25447-D32SXXXXK6X	1.500(38.10)	1.620(41.14)	72	FFH25447-D72SXXXXK6X	3.500(88.90)	3.620(91.94)
34	FFH25447-D34SXXXXK6X	1.600(40.64)	1.720(43.68)	74	FFH25447-D74SXXXXK6X	3.600(91.44)	3.720(94.48)
36	FFH25447-D36SXXXXK6X	1.700(43.18)	1.820(46.22)	76	FFH25447-D76SXXXXK6X	3.700(93.98)	3.820(97.02)
38	FFH25447-D38SXXXXK6X	1.800(45.72)	1.920(48.76)	78	FFH25447-D78SXXXXK6X	3.800(96.52)	3.920(99.56)
40	FFH25447-D40SXXXXK6X	1.900(48.26)	2.020(51.30)	80	FFH25447-D80SXXXXK6X	3.900(99.06)	4.020(102.10)
42	FFH25447-D42SXXXXK6X	2.000(50.80)	2.120(53.84)				

 THIRD ANGLE PROJECTION	GENERAL TOLERANCES (UNLESS SPECIFIED)		APPROVE BY FRANK	DATE 12/AUG/13	PART NO. FFH25447-DXXSXXXXK6X	ITEM NO. FFH25447	 Leader Of Industry	
	X.±.012(0.30)	X.±5'	CHECKED BY CHERRY	DATE 12/AUG/13	TITLE Board to Board (Female Header) Pitch 2.54mm 180° Vertical (DIP)	REV 0		SHEET NO. 2/2
	DESIGN UNITS Inch (metric)	X.X±.008(0.20)	.X±2'	DRAWN BY JACOB	DATE 12/AUG/13	THIS DRAWING CONTAINS INFORMATION THAT IS PROPRIETARY TO TXGA INDUSTRIAL ELECTRONICS(S.Z)CO.,LTD AND SHOULD NOT BE USED WITHOUT WRITTEN PERMISSION		
	SCALE 5:1	SIZE A4	X.XX±.006(0.15)	.XX±1'	X.XXX±.004(0.10)	.XX±0.5'		

1 2 3 4 5 6 7 8