

REV	LOCATIONS	DESCRIPTION	DATE	REVISER	APPD
1	△	structure and size changes	31/MAR/22	MATT	CHERRY

SPECIFICATIONS

Electrical Performances

Current Rating: 1.5A AC(rms)/DC
Voltage Rating: 125V AC(rms)/DC
Contact Resistance: 30 mΩ Max
Insulation Resistance: 500 MΩ MIN
Withstanding Voltage: 1000V AC r.m.s
Temperature Range—Operating: -40°C~+85°C

Material and Plating

Housing: PA46 UL94V-0
Contact: Phosphor Bronze/Gold Plated
Shell: Copper Alloy/Nickel Plated

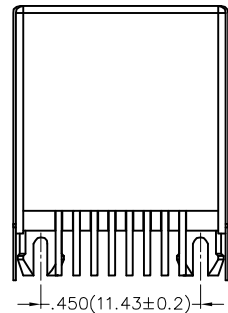
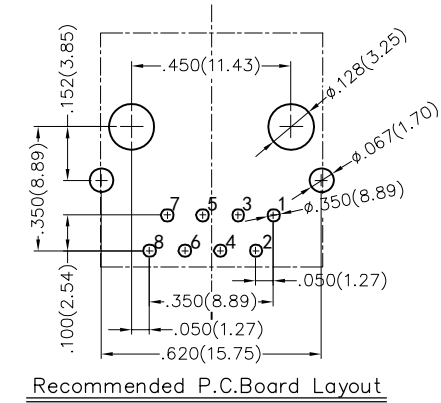
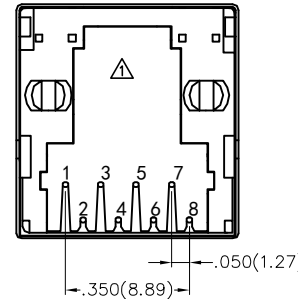
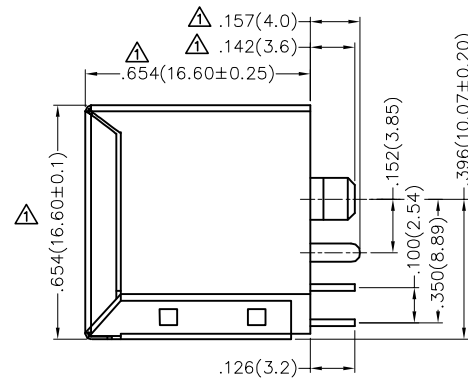
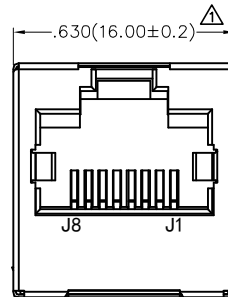
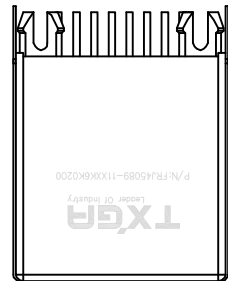

Ordering Information

FRJ45 089 — 1 1 XX K6 K 0 2 0 0
1 2 3 4 5 6 7 8

1 Category FRJ45-RJ45 Connector	2 Distinction No. 089	3 Ports options 1-1 Port	4 Plating 1-Gold Plated
5 Thickness of plating 00-Gold flash 03-3μ" Custom plate available	6 Color-Resin K6-Black	7 Packaging K-Tray	8 Contact type 2-Round pin

THIRD ANGLE PROJECTION	GENERAL TOLERANCES (UNLESS SPECIFIED)		APPROVE BY FRANK	DATE 18/JUN/18	PART NO. FRJ45089-11XXK6K0200	ITEM NO. FRJ45089	 Leader Of Industry
	DESIGN UNITS Inch (metric)	X.±.012(0.30) X.X±.008(0.20) X.XX±.006(0.15) X.XXX±.004(0.10)	X.±5° .X'±2° .XX'±1° .XXX'±0.5°	CHECKED BY CHERRY	DATE 18/JUN/18	TITLE RJ45 Connector 8P8C 180° Vertical	
SCALE 5:1	SIZE A4		DRAWN BY KATE	DATE 18/JUN/18	THIS DRAWING CONTAINS INFORMATION THAT IS PROPRIETARY TO TXGA INDUSTRIAL ELECTRONICS(S.Z)CO.,LTD AND SHOULD NOT BE USED WITHOUT WRITTEN PERMISSION		