

| REV | LOCATIONS | DESCRIPTION              | DATE      | REVISER | APPD   |
|-----|-----------|--------------------------|-----------|---------|--------|
| 1   | △         | Size & Structure changes | 28/DEC/21 | MATT    | CHERRY |

Notes:

1. Material: Phosphor Bronze
2. Plating: Tin Plated
3. Wire Range: 26AWG~30AWG
4. Applicable Housing: FHG12507 Series
5. Minimum Order Quantity: 20,000 pcs

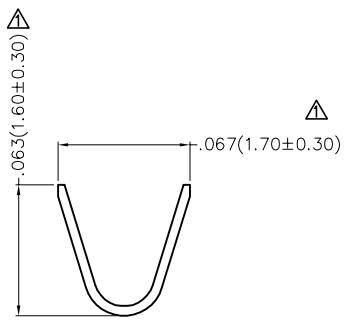
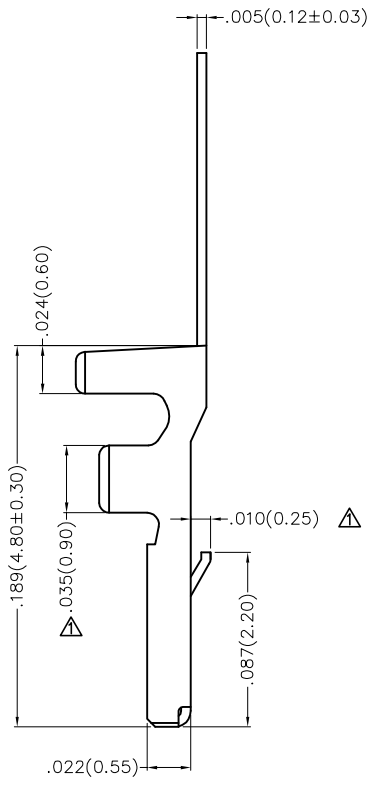
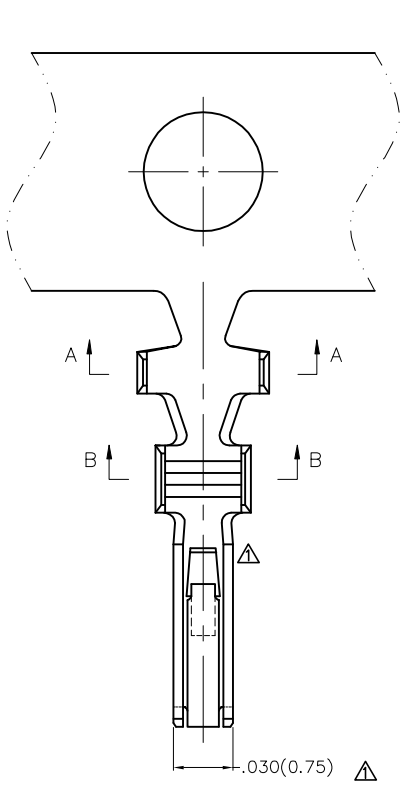

Section A-A

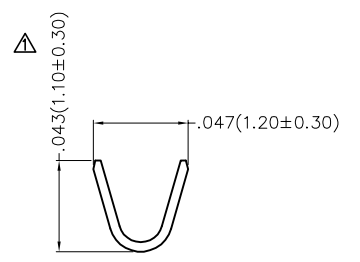

Section B-B

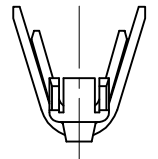

|                                       |  |                         |                              |                           |   |                             |                           |              |                      |
|---------------------------------------|--|-------------------------|------------------------------|---------------------------|---|-----------------------------|---------------------------|--------------|----------------------|
| <p>THIRD ANGLE PROJECTION</p>         | <p>GENERAL TOLERANCES (UNLESS SPECIFIED)</p> |                         | <p>APPROVE BY<br/>FRANK</p>  | <p>DATE<br/>10/DEC/14</p> | <p>PART NO.<br/>FT12508-F2H</p>   | <p>ITEM NO.<br/>FT12508</p> | <p>Leader Of Industry</p> |              |                      |
|                                       | <p>X.±.012(0.30)</p>                         | <p>X'.±5'</p>           | <p>CHECKED BY<br/>CHERRY</p> | <p>DATE<br/>10/DEC/14</p> | <p>TITLE<br/>Wire to Board<br/>Pitch 1.25mm(Terminal)</p>   |                             |                           | <p>REV 1</p> | <p>SHEET NO. 1/2</p> |
|                                       | <p>X.X±.008(0.20)</p>                        | <p>.X'±2"</p>           | <p>DRAWN BY<br/>KATE</p>     | <p>DATE<br/>10/DEC/14</p> | <p>THIS DRAWING CONTAINS INFORMATION THAT IS PROPRIETARY TO TXGA INDUSTRIAL ELECTRONICS(S.Z)CO.,LTD AND SHOULD NOT BE USED WITHOUT WRITTEN PERMISSION</p> |                             |                           |              |                      |
| <p>DESIGN UNITS<br/>Inch (metric)</p> | <p>X.XX±.006(0.15)</p>                       | <p>.XX'±1"</p>          |                              |                           |   |                             |                           |              |                      |
| <p>SCALE<br/>5:1</p>                  | <p>SIZE<br/>A4</p>                           | <p>X.XXX±.004(0.10)</p> | <p>.XXX'±0.5"</p>            |                           |   |                             |                           |              |                      |

| REV | LOCATIONS | DESCRIPTION | DATE | REVISER | APPD |
|-----|-----------|-------------|------|---------|------|
|     |           |             |      |         |      |

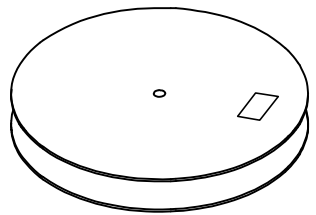
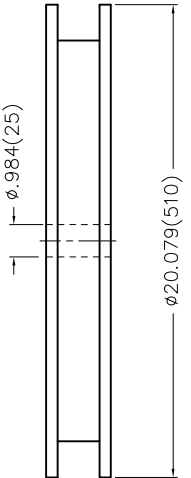
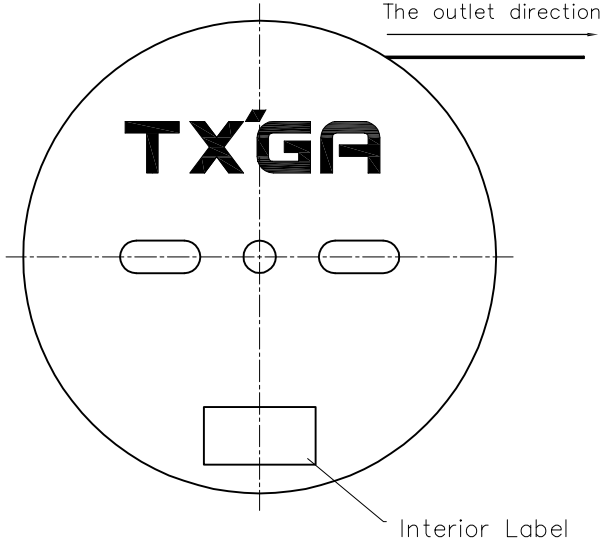

20,000 Pcs/Reel

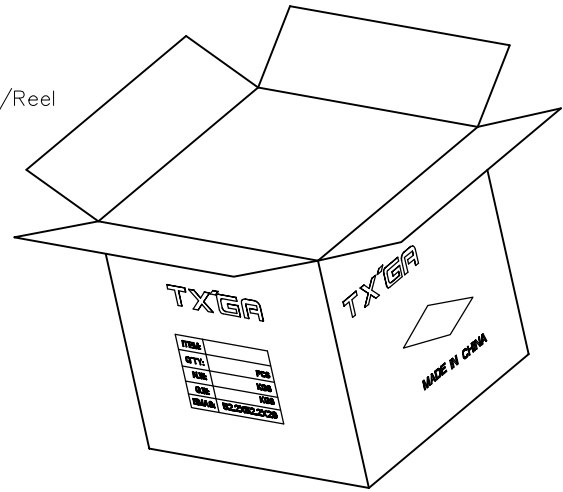

|                               |                                       |            |            |           |  |          |                           |
|-------------------------------|---------------------------------------|------------|------------|-----------|--|----------|---------------------------|
| <p>THIRD ANGLE PROJECTION</p> | GENERAL TOLERANCES (UNLESS SPECIFIED) |            | APPROVE BY | DATE      | PART NO.   | ITEM NO. | <p>Leader Of Industry</p> |
|                               | X.±.012(0.30)                         | X.±5'      | FRANK      | 10/DEC/14 | FT12508-F2H  | FT12508  |                           |
| DESIGN UNITS<br>Inch (metric) | X.X±.008(0.20)                        | .X'±2"     | CHECKED BY | DATE      | TITLE  |          | REV 1                     |
| SCALE                         | X.XX±.006(0.15)                       | .XX'±1"    | CHERRY     | 10/DEC/14 | Wire to Board<br>Pitch 1.25mm(Terminal)  |          |                           |
| 5:1                           | X.XXX±.004(0.10)                      | .XXX'±0.5" | DRAWN BY   | DATE      | THIS DRAWING CONTAINS INFORMATION THAT IS PROPRIETARY TO TXGA INDUSTRIAL ELECTRONICS(S.Z)CO.,LTD AND SHOULD NOT BE USED WITHOUT WRITTEN PERMISSION |          |                           |
| SIZE<br>A4                    |                                       |            | KATE       | 10/DEC/14 |  |          |                           |