

REV	LOCATIONS	DESCRIPTION	DATE	REVISER	APPD

Electrical
 Material: Phosphor Bronze
 Plating: Tin-Plated
 Wire Range: 18AWG~22AWG
 Insulation Nom.Dia: ϕ .098"Max (ϕ 1.5~ ϕ 2.5mm)
 Applicable Housing: FHG41403 Series
 Minimum Order Quantity : 4,500 pcs

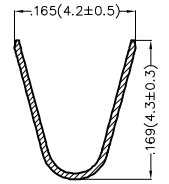

Section A-A

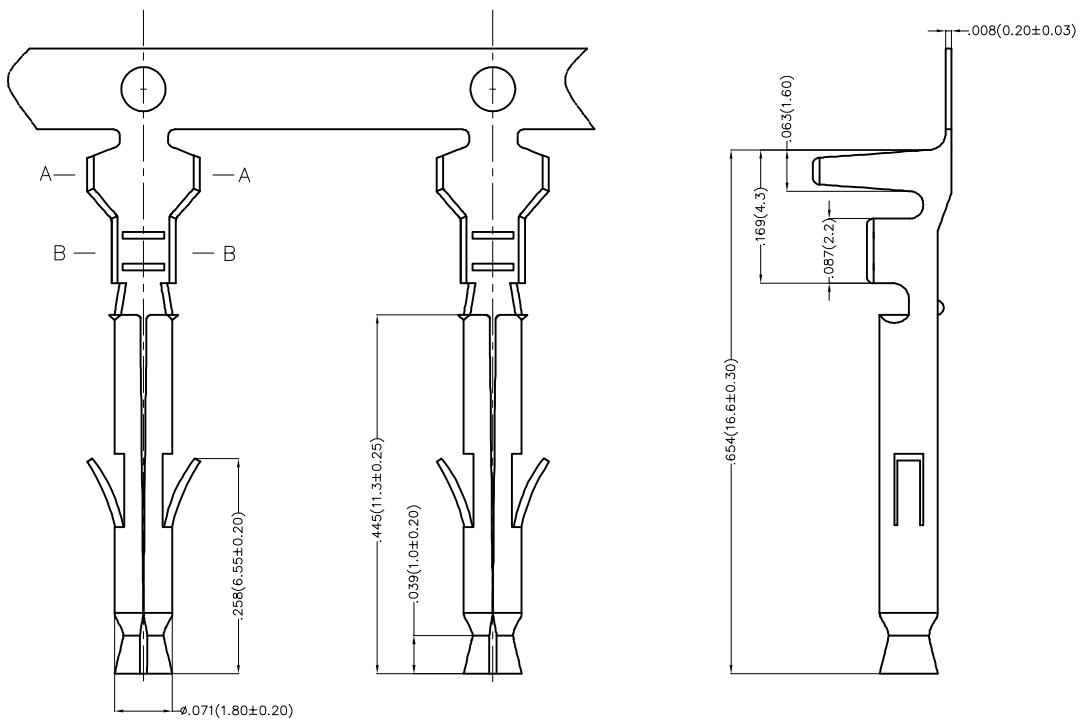
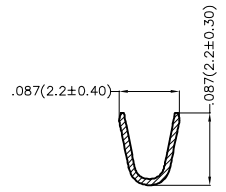

Section B-B

 THIRD ANGLE PROJECTION	GENERAL TOLERANCES (UNLESS SPECIFIED)		APPROVE BY FRANK	DATE 15/AUG/22	PART NO. FT41403-F2H	ITEM NO. FT41403	 Leader Of Industry
	DESIGN UNITS Inch (metric)	X. \pm .012(0.30)	X. \pm 5'	CHECKED BY CHERRY	DATE 15/AUG/22	TITLE Wire to Board Pitch 4.14mm(Terminal)	
SCALE 5:1	SIZE A4	X.XX \pm .006(0.15)	.XX \pm 1'	DRAWN BY MATT	DATE 15/AUG/22	THIS DRAWING CONTAINS INFORMATION THAT IS PROPRIETARY TO TXGA INDUSTRIAL ELECTRONICS(S.Z)CO.,LTD AND SHOULD NOT BE USED WITHOUT WRITTEN PERMISSION	
		X.XXX \pm .004(0.10)	.XXX \pm 0.5'			REV 0	SHEET NO. 1/2

1 2 3 4 5 6 7 8

REV	LOCATIONS	DESCRIPTION	DATE	REVISER	APPD

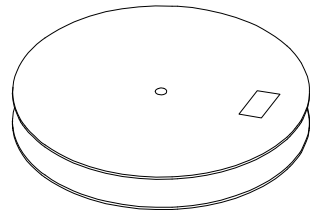
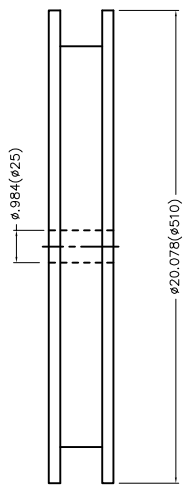
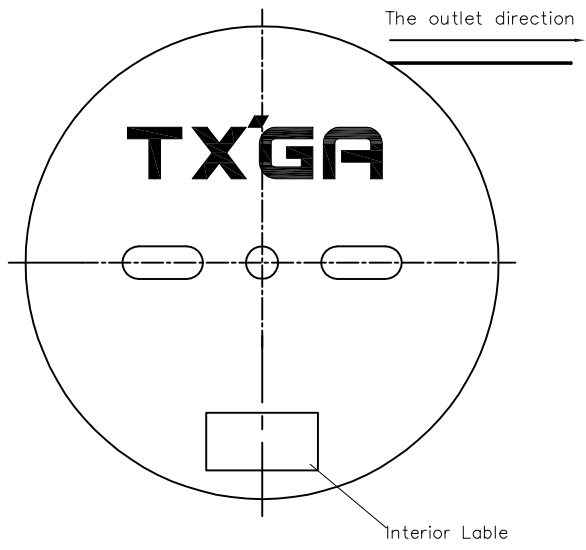

4,500 Pcs/Reel

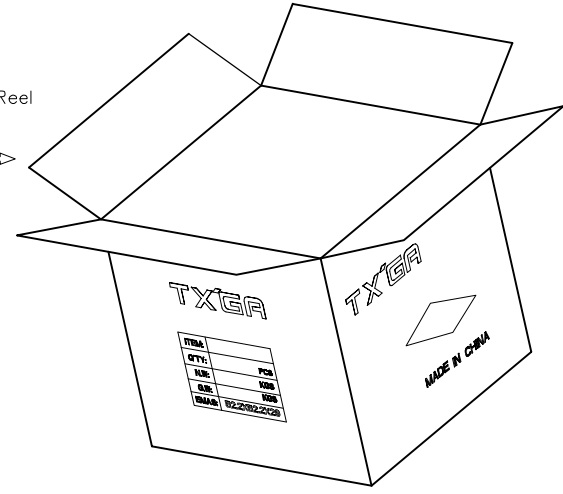

A
B
C
D
E
F

A
B
C
D
E
F

 THIRD ANGLE PROJECTION	GENERAL TOLERANCES (UNLESS SPECIFIED)		APPROVE BY FRANK	DATE 15/AUG/22	PART NO. FT41403-F2H	ITEM NO. FT41403	 Leader Of Industry
	X.±.012(0.30)	X.*±5'	CHECKED BY CHERRY	DATE 15/AUG/22	TITLE Wire to Board Pitch 4.14mm(Terminal)		
DESIGN UNITS Inch (metric)	X.XX±.008(0.20)	.X*±2'	DRAWN BY MATT	DATE 15/AUG/22	THIS DRAWING CONTAINS INFORMATION THAT IS PROPRIETARY TO TXGA INDUSTRIAL ELECTRONICS(S.Z)CO.,LTD AND SHOULD NOT BE USED WITHOUT WRITTEN PERMISSION		
SCALE 5:1	SIZE A4	X.XXX±.004(0.10)	.XXX*±0.5'				

1 2 3 4 5 6 7 8