

REV	LOCATIONS	DESCRIPTION	DATE	REVISER	APPD
1	△	MOQ: Change 4,000 into 3,500 pcs/reel	09/NOV/21	MATT	CHERRY
2	△	Change Applicable Housing	08/AUG/24	KATE	LEO

Electrical

Material: Phosphor Bronze

Plating: Tin plated

Wire Range: 14AWG~20AWG

Applicable Housing: FHG67001 Series △

Minimum Order Quantity : 3,500 pcs △

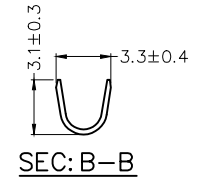
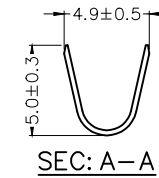
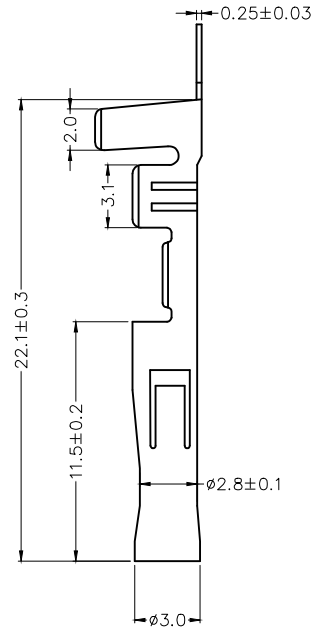
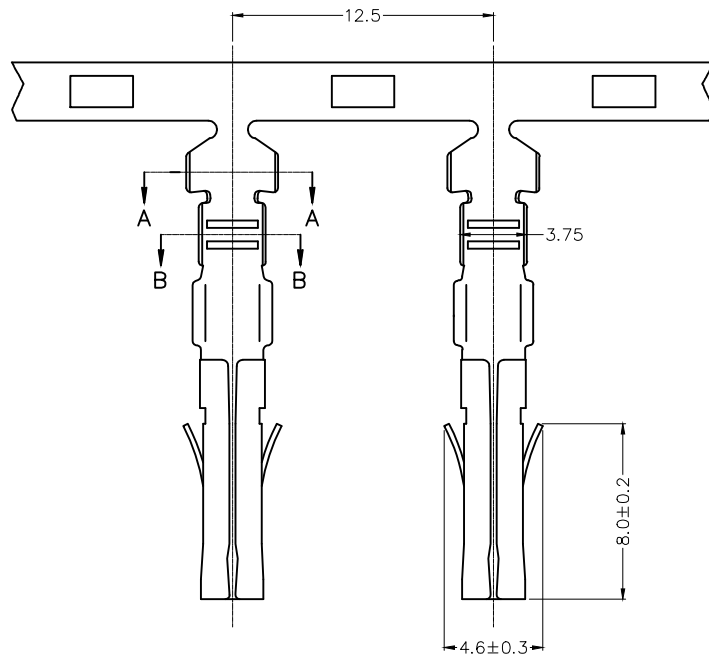

 THIRD ANGLE PROJECTION	GENERAL TOLERANCES (UNLESS SPECIFIED)		APPROVE BY FRANK	DATE 18/JUN/13	PART NO. FT50301-F2H	ITEM NO. FT50301	 Leader Of Industry
	DESIGN UNITS Inch (metric)	X.±.012(0.30) X.X±.008(0.20)	X.±5' .X±2'	CHECKED BY CHERRY	DATE 18/JUN/13	TITLE Wire to Board Pitch 5.03mm(Terminal)	
SCALE 5:1	SIZE A4	X.XX±.006(0.15) X.XXX±.004(0.10)	.XX±1' .XXX±0.5'	DRAWN BY KATE	DATE 18/JUN/13	THIS DRAWING CONTAINS INFORMATION THAT IS PROPRIETARY TO TXGA INDUSTRIAL ELECTRONICS(S.Z)CO.,LTD AND SHOULD NOT BE USED WITHOUT WRITTEN PERMISSION	
						REV 2	SHEET NO. 1/2

REV	LOCATIONS	DESCRIPTION	DATE	REVISER	APPD

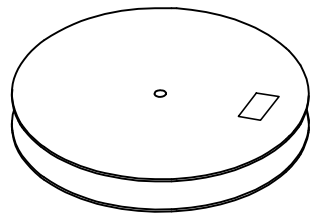
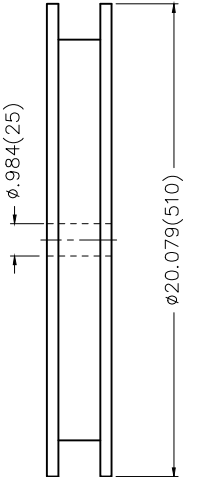
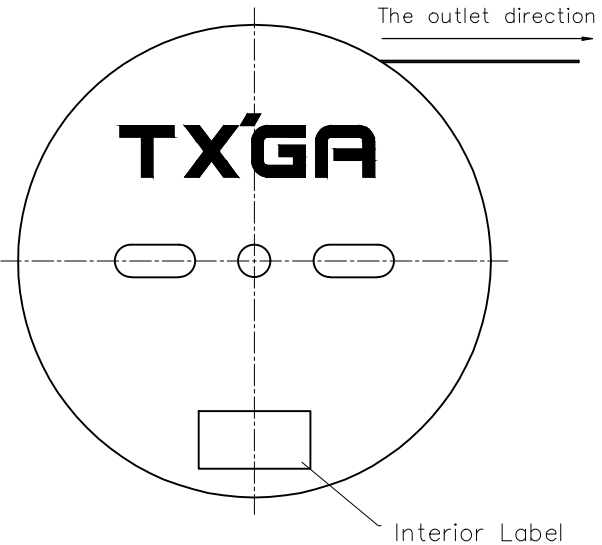

3,500 Pcs/Reel

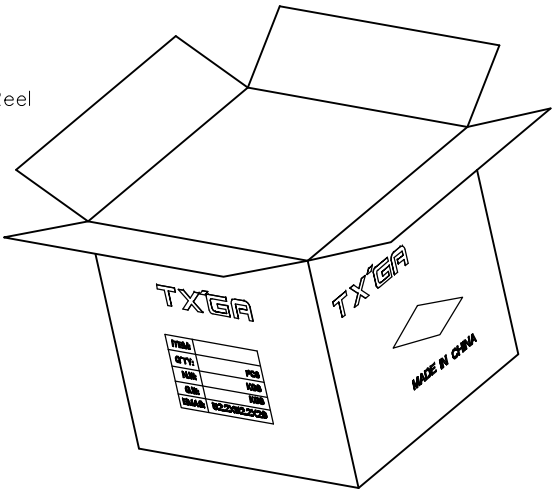

<p>THIRD ANGLE PROJECTION</p>	GENERAL TOLERANCES (UNLESS SPECIFIED)		APPROVE BY	DATE	PART NO.	ITEM NO.	<p>Leader Of Industry</p>	
	X. \pm .012(0.30)	X. \pm 5'	FRANK	18/JUN/13	FT50301-F2H	FT50301		
	X.X \pm .008(0.20)	.X \pm 2'	CHECKED BY	DATE	TITLE			
DESIGN UNITS Inch (metric)	X.XX \pm .006(0.15)	.XX \pm 1'	CHERRY	18/JUN/13	Wire to Board Pitch 5.03mm(Terminal)		REV 2	SHEET NO. 2/2
SCALE 5:1	X.XXX \pm .004(0.10)	.XXX \pm 0.5'	DRAWN BY	DATE	THIS DRAWING CONTAINS INFORMATION THAT IS PROPRIETARY TO TXGA INDUSTRIAL ELECTRONICS(S.Z)CO.,LTD AND SHOULD NOT BE USED WITHOUT WRITTEN PERMISSION			
SIZE A4			KATE	18/JUN/13				