

REV	LOCATIONS	DESCRIPTION	DATE	REVISER	APPD
1	△	MOQ: Change 5,000 into 4,000 pcs/reel	14/MAY/18	KATE	FRANK
2	△	Structural changes, MPQ: 5,000 pcs/reel	11/MAY/21	KATE	CHERRY
3	△	Structural changes, MPQ: 3,500 pcs/reel	09/NOV/21	MATT	CHERRY
4	△	Change Applicable Housing	08/AUG/24	KATE	LEO

Electrical
Material: Phosphor Bronze
Plating: Tin plated
Wire Range: 14AWG~20AWG
Insulation O.D.: .122(3.10) Max.
Applicable Housing: FHG67002 Series △
Minimum Order Quantity : 3,500 pcs

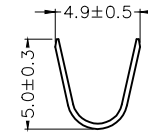

SEC: A-A

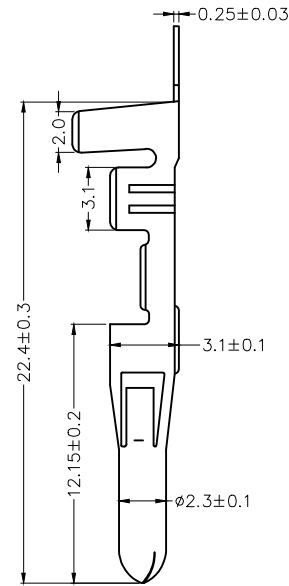
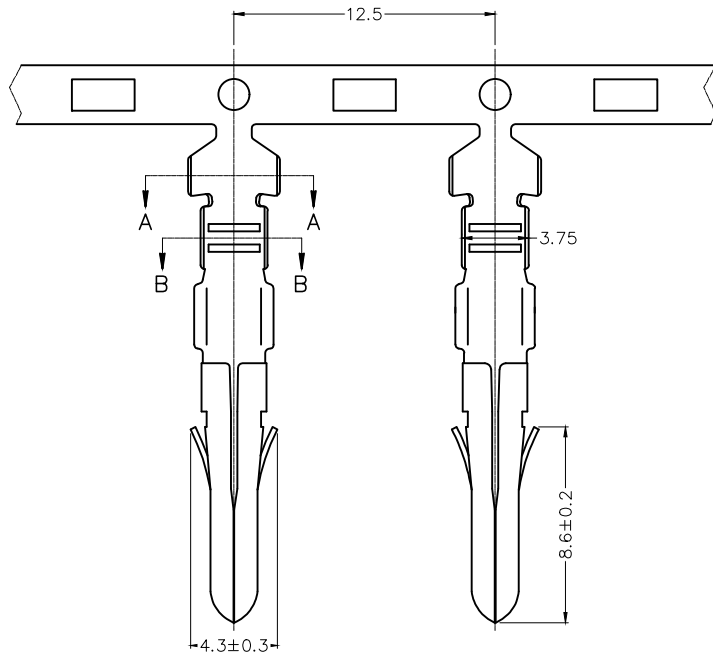
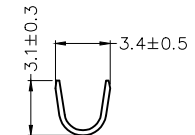

SEC: B-B

 THIRD ANGLE PROJECTION	GENERAL TOLERANCES (UNLESS SPECIFIED)		APPROVE BY FRANK	DATE 18/JUN/13	PART NO. FT50302-M2H	ITEM NO. FT50302	 Leader Of Industry
	DESIGN UNITS Inch (metric)	X.±.012(0.30)	X.±5'	CHECKED BY CHERRY	DATE 18/JUN/13	TITLE Wire to Board Pitch 5.03mm(Terminal)	
SCALE 5:1	SIZE A4	X.XX±.006(0.15)	.XX'±1'	DRAWN BY KATE	DATE 18/JUN/13	THIS DRAWING CONTAINS INFORMATION THAT IS PROPRIETARY TO TXGA INDUSTRIAL ELECTRONICS(S.Z)CO.,LTD AND SHOULD NOT BE USED WITHOUT WRITTEN PERMISSION	
		X.XXX±.004(0.10)	.XXX'±0.5'			REV 4	SHEET NO. 1/2

REV	LOCATIONS	DESCRIPTION	DATE	REVISER	APPD

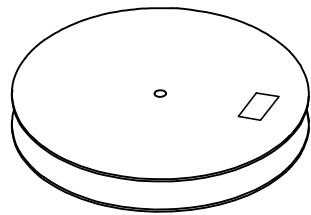
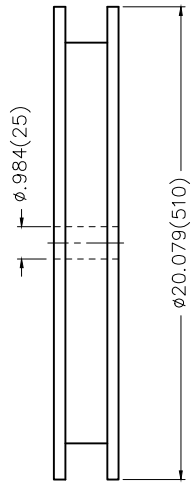
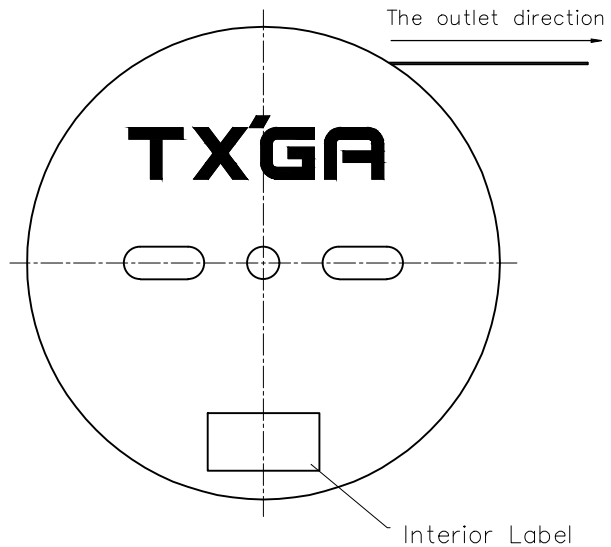

3,500 Pcs/Reel

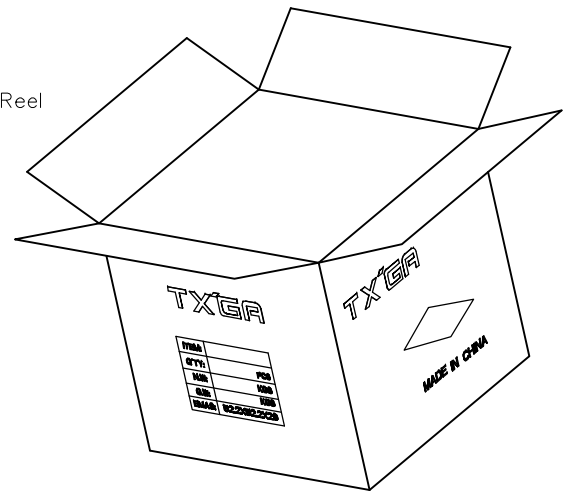

 THIRD ANGLE PROJECTION	GENERAL TOLERANCES (UNLESS SPECIFIED)		APPROVE BY FRANK	DATE 18/JUN/13	PART NO. FT50302-M2H	ITEM NO. FT50302	 Leader Of Industry
	X. \pm .012(0.30)	X. \pm 5'	CHECKED BY CHERRY	DATE 18/JUN/13	TITLE Wire to Board Pitch 5.03mm(Terminal)		
DESIGN UNITS Inch (metric)	X.X \pm .008(0.20)	.X \pm 2'	DRAWN BY KATE	DATE 18/JUN/13	THIS DRAWING CONTAINS INFORMATION THAT IS PROPRIETARY TO TXGA INDUSTRIAL ELECTRONICS(S.Z)CO.,LTD AND SHOULD NOT BE USED WITHOUT WRITTEN PERMISSION		
SCALE 5:1	SIZE A4	X.XX \pm .006(0.15)	.XX \pm 1'				
		X.XXX \pm .004(0.10)	.XXX \pm 0.5'				