

REV	LOCATIONS	DESCRIPTION	DATE	REVISER	APPD
1	△	Description Change	19/JUL/23	YYQ	LEO
2	△	Update dimensions and structures	17/JUN/25	MATT	LEO

SPECIFICATIONS

Material: Copper alloy  
 Plating: 1μ gold in contact area, Nickel plated over all  
 Wire range: 28AWG~24AWG  
 Applicable Housing: FDBXX37-F0 Series  
 Minimum order quantity: 15,000 pcs

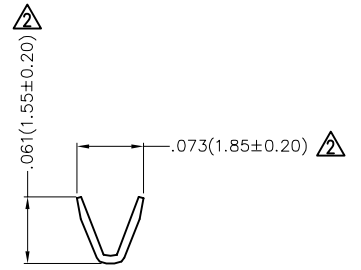
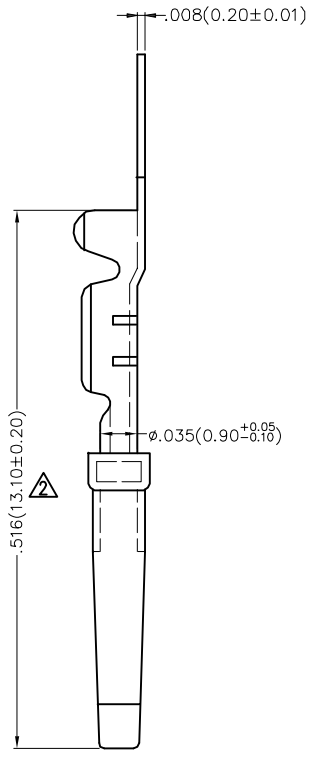
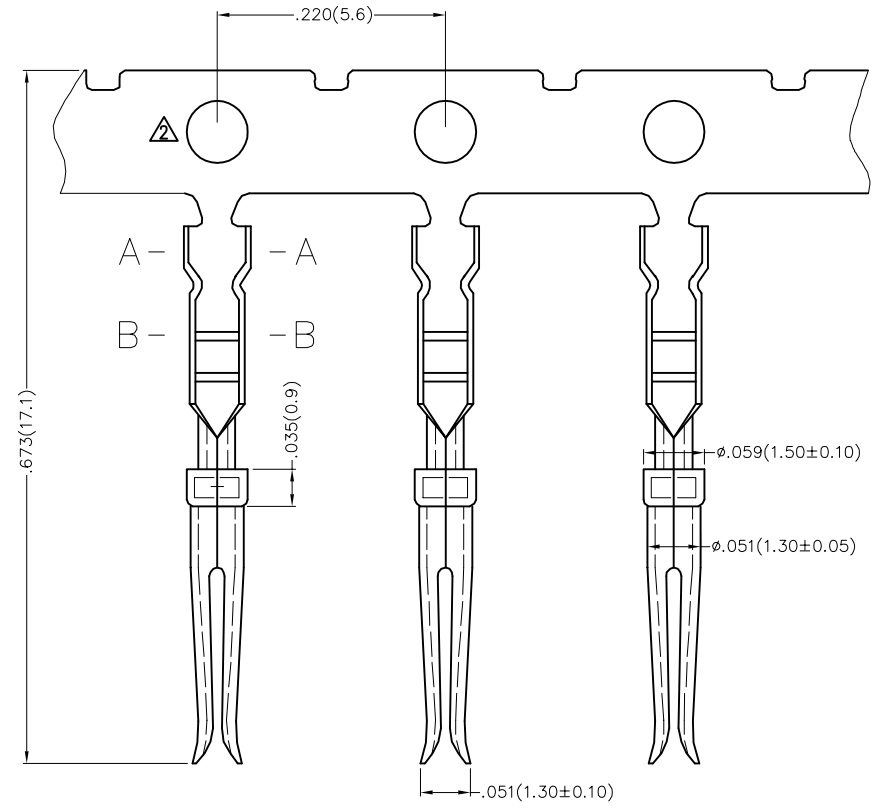

Section A-A

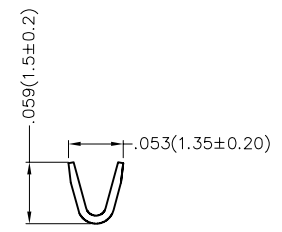

Section B-B

 THIRD ANGLE PROJECTION	GENERAL TOLERANCES (UNLESS SPECIFIED)		APPROVE BY	DATE	PART NO.	ITEM NO.	 Building Technology Cornerstone
	X.±.012(0.30)	X.±5'	FRANK	28/DEC/18	FTDB002-F3H	FTDB002	
	X.X±.008(0.20)	.X'±2'	CHECKED BY	DATE	TITLE		REV 2
	X.XX±.006(0.15)	.XX'±1'	CHERRY	28/DEC/18	D-SUB Connector Terminal(Female)		SHEET NO. 1/2
SCALE	SIZE	X.XXX±.004(0.10)	.XXX'±0.5'	DRAWN BY	DATE	THIS DRAWING CONTAINS INFORMATION THAT IS PROPRIETARY TO TXGA INDUSTRIAL ELECTRONICS(S.Z)CO.,LTD AND SHOULD NOT BE USED WITHOUT WRITTEN PERMISSION	
5:1	A4			KATE	28/DEC/18		

REV	LOCATIONS	DESCRIPTION	DATE	REVISER	APPD

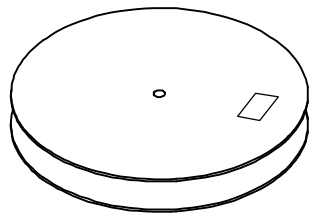
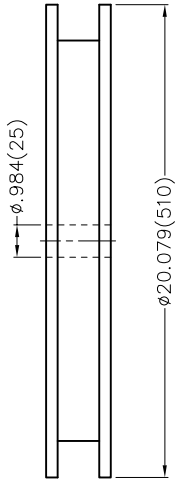
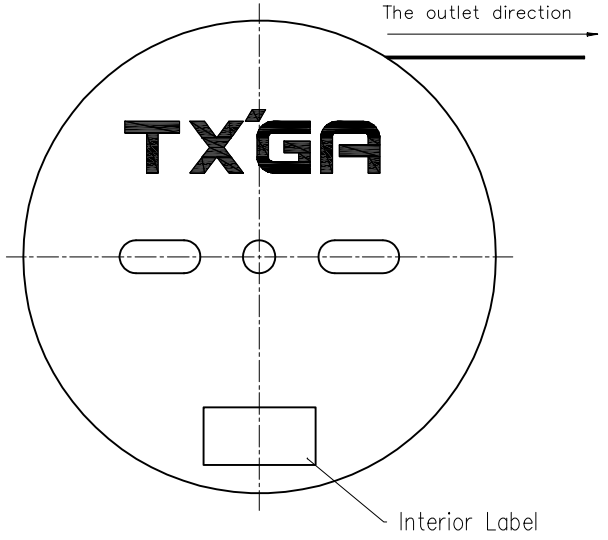

15,000 Pcs/Reel

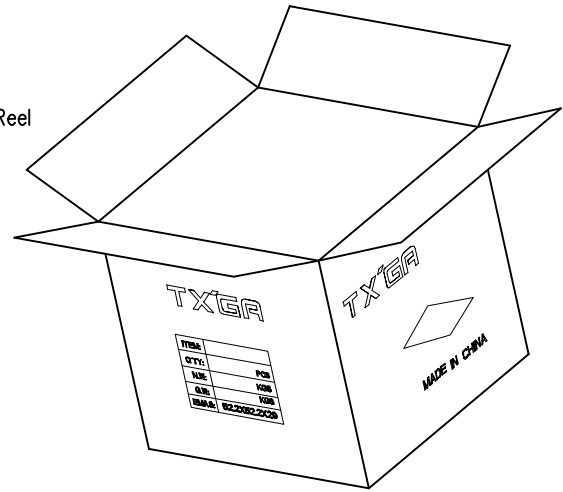

<p>THIRD ANGLE PROJECTION</p>	GENERAL TOLERANCES (UNLESS SPECIFIED)		APPROVE BY	DATE	PART NO.	ITEM NO.	<p>Building Technology Cornerstone</p>
	X.±.012(0.30)	X.±5'	FRANK	28/DEC/18	FTDB002-F3H	FTDB002	
	DESIGN UNITS Inch (metric)	X.X±.008(0.20)	.X±2'	CHECKED BY	DATE	TITLE	
SCALE 5:1	X.XX±.006(0.15)	.XX±1'	CHERRY	28/DEC/18	D-SUB Connector Terminal(Female)		SHEET NO. 2/2
SIZE A4	X.XXX±.004(0.10)	.XXX±0.5'	DRAWN BY	DATE	THIS DRAWING CONTAINS INFORMATION THAT IS PROPRIETARY TO TXGA INDUSTRIAL ELECTRONICS(S.Z)CO.,LTD AND SHOULD NOT BE USED WITHOUT WRITTEN PERMISSION		
			KATE	28/DEC/18			